Product Guide

Morgan Bros.
Millwork, Inc.

Specifications Catalog

- Custom Cabinet Doors
- Custom Moulding
- Custom Drawer Boxes

CONTENTS

| | |
|--|-------|
| Customer Service Representatives | 4 |
| Ordering Information | 5 |
| Wood Specifications | 6–7 |
| Finishing | 8 |
| Cope & Stick Rail & Stile Profiles | 9 |
| Door & Drawer Front Panel Profiles | 10 |
| Edge Profiles | 11 |
| Doors | |
| Solid Wood - Raised Panels | 12–13 |
| Solid Wood - Plywood Panels | 14–15 |
| Shaker - Solid Wood - Raised Panel | 16 |
| Shaker - Solid Wood - Reversed Panel | 17 |
| Shaker - Plywood Panel | 18 |
| Mitered Corner - Solid Wood - Raised Panel | 19 |
| Mitered Corner - Plywood Panel | 20 |
| Solid Wood - Glass Panel | 21–22 |
| Cope & Stick 200 Series Grid Patterns | 24 |
| Shaker - Glass Panel | 25 |
| Mitered Corner 200 Series Grid Patterns | 26 |
| MDF - 400 Series - Raised Panels | 28 |
| MDF - 400 Series - Glass Panels | 29 |
| MDF - 300 Series - Raised Panels | 30 |
| MDF - 300 Series - Glass Panels | 31 |
| MDF - Grid Patterns | 28 |
| Drawer Fronts | |
| Solid Wood Slabs | 34–35 |
| Cope & Stick | 36 |
| Shaker - Solid Wood - Raised Panel | 37 |
| Shaker - Solid Wood - Reversed Panel | 38 |
| Shaker - Solid Wood - Plywood Panel | 39 |
| Mitered Corner - Raised Panel | 40 |
| Mitered Corner - Plywood Panel | 41 |
| MDF - Raised Panel | 42 |
| Wainscot - End Panels Barbacks | 43 |
| Hinge Prep | 44 |
| Appliance Panels | 45 |
| Drawer Boxes | 46 |
| Moulding | 47–54 |

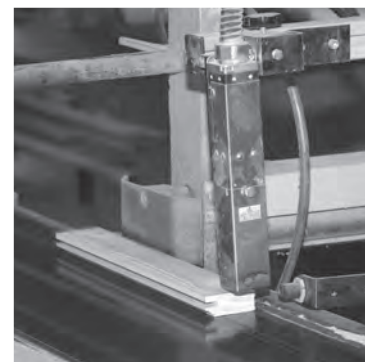

WELCOME

Welcome to the Morgan Bros. Product Guide and Specifications Catalog. We hope the technical information, drawings, and cross sections will provide you with the necessary information to place your order. Since 1980, our goal has been to create customer satisfaction by providing quality cabinet doors, delivered on time. Our success is the direct result of the confidence that our customers place in us, week after week, with repeat orders. Please give us a call, we are ready to serve you.

For General Information

- 601-649-9188
- 800-627-3667
- www.morganbros.net



CUSTOMER SERVICE REPRESENTATIVES



Sybille Nielsen - Laurel Area
Phone: 601-425-0900
Email: sybille@morganbros.net



Debbie Ruffin
Phone: 866-219-1649 • Fax: 866-219-1651
Email: debbie@morganbros.net



Tisha Bounds
Phone: 866-857-4302 • Fax: 866-857-4304
Email: tisha@morganbros.net



Alyson Elkins
Phone: 866-446-9460 • Fax: 866-446-9461
Email: alyson@morganbros.net



Jennifer Sims
Phone: 866-857-4298 • Fax: 866-857-4299
Email: jennifer@morganbros.net



Donna Mason
Phone: 866-446-9464 • Fax: 866-857-4301
Email: dmason@morganbros.net

Morgan Bros.
Millwork, Inc.

ORDERING INFORMATION

To assure that each order is processed and delivered correctly, the same customer representative will work with you on each of your orders. Your customer representative will:

- Receive your order
- Clarify any questions about the order
- Fax, e-mail, or U.S. mail your confirmation
- Track the status of your order through the plant
- Contact you the day before shipping to arrange delivery and payment
- Maintain a file with all current and past orders.

Each customer representative will receive your order via:

- Direct toll free number with voice mail
- Direct toll free fax number
- E-mail

If your customer representative is on the telephone when you call, PLEASE, PLEASE, PLEASE leave a voice mail! Our goal is to return your phone call as soon as possible.

The following information is needed to process your order successfully:

- Door and drawer style
- Wood specie
- Rail profile (page 9)
- Panel profile (page 10)
- Edge profile (page 11)
- Door and drawer sizes (opening sizes will not be accepted)
- A drawing or template for all special doors, end panels, arch panels, and range hoods.
- **All doors over 48" in height will be double paneled unless otherwise specified by the customer.**

Payment Terms

All orders are C.O.D.

- Pre pay: check by fax
- We accept Visa, MasterCard, Discover, and American Express

Shipping

Most orders within our shipping area are delivered within 5–10 working days, by Morgan Bros. trucks. All other orders are shipped UPS or freight and will be subject to a package and shipping charge.

For General Information

- 601-649-9188
- 800-627-3667
- Fax 601-425-9732
- **Catalog Online**
www.morganbros.net
- **Mailing Address**
PO Box 4343 • Laurel, MS 39441
- **Physical Address**
#1 Bruce Avenue • Laurel, MS 39440

WOOD SPECIFICATIONS

Wood is a beautiful, naturally occurring product. A variety of grain patterns and color tones will exist in the same wood specie. Growing conditions such as the amount of rainfall, soil type, sunlight, minerals, and temperature contribute to these variations. Natural characteristics in the wood such as varying color shades, grain patterns, burl, pin knots, mineral deposits, and sap are not considered defects. We hope that the general descriptions of our stock wood species will be helpful as you select your wood.

Alder is a soft grain, light creamy, brownish wood. It easily absorbs stain and has a reasonable blend of color tones. Alder is not color selected and can be finished to look similar to cherry and mahogany. It does contain some pin knots and can blotch if the stain is not applied correctly.

Rustic Alder is the same as alder but with solid knots and open knots. The number and size of knots will vary from door to door.

Sapele Sapele is a reddish-brown wood that in many ways is very similar to Mahogany. It is a great alternative to genuine Mahogany.

African Mahogany is a brownish wood with lighter tannish streaks throughout. Ribboning is a common characteristic with grain patterns and density similar to genuine mahogany.

Ash is a hard, wide wavy grained, light-brown to tannish white wood. Ash naturally has variation in color tones but can be color selected to achieve closer color tones in each color.

Basswood is a soft grained creamy off white wood. Basswood absorbs stain well but may be blotchy if not applied correctly.

Beech (European) is a hard straight grained slightly pinkish wood. It has very consistent color tones with a uniform appearance.

Cherry is a hard tight grained reddish- brown wood with some variation in color tones. Some gum pockets and slight sap are not considered defects.

Yellow Cypress is a soft wide grained wood with color tones ranging from creamy yellow to orange to brown. Cypress easily absorbs stain but is less stable than other woods. Cypress doors carry no warranty.

Knotty Cypress (yellow) is the same as yellow cypress but with more color variation and solid knots. The number and size of knots will vary from door to door. Knotty cypress doors carry no warranty.

Knotty White Pine is a soft grained light creamy wood with yellowish and brownish color tone and solid knots. The number and size of knots will vary from door to door. It is also less stable than other woods.

WOOD SPECIFICATIONS

- Hickory/
Pecan** is a very hard, very tight grained creamy to brown wood. It does not absorb stain well and will have a wide range of wood color in each door and is not color selected.
- Rustic
Hickory/
Pecan** is the same as hickory but with solid and open knots in which the number and size of knots will vary from door to door.
- Northern
Hard Maple** is a very hard, soft grained wood that is light yellowish to white wood. Hard maple does not absorb stain well but is very consistent in color.
- Northern
Soft Maple** is a hard, soft grained wood with color tones ranging from creamy white to soft browns. Soft maple is not a color selected wood and absorbs stain with difficulty.
- Poplar** is a soft grained with color tones that range from creamy white to brown, with greens and black. It absorbs stain with ease and is not a color selected wood.
- Red Oak
(Northern)** is a hard wide grained wood with color tones ranging from light reds to deeper reddish tones. Red oak absorbs stain easily and can be color selected.
- White Oak** is a hard wide grained wood with tannish to brown color tones. White oak stains and finishes well, and is not a color selected wood.
- Walnut** is a hard tight grained rich dark brown with slight lighter brown wood tones and touches of sap. Walnut stains well.
- Southern
Yellow Pine** is a wide grained wood with a yellow color that easily absorbs stain, but is less stable than other woods. Southern yellow pine doors carry no warranty.
- 1/4"
Plywood
Veneers** are used in our flat panel doors and are available in the following species: ash, beech, basswood, cherry, cypress, knotty white pine, soft maple, hard maple, red oak, white oak, walnut, and alder. (Note: we use red birch in alder and soft maple in basswood.)
- MDF** (Medium Density Fiberboard) consists of finely ground wood materials mixed with a high bond resin glue. MDF is a paintable material only.
- Medex** is a moisture resistant form of MDF that is good for use in outdoor covered areas.
- Extira** is a moisture proof form of MDF that is good for all exterior applications.

NOTE: Depending upon availability, there are many other wood species that can be special ordered such as: reclaimed heart pine, reclaimed cypress, sinker cypress, and others. These non stock species are special quote only and will require longer lead times for production.

FINISHING

The first rule when finishing your cabinet doors is: “be careful.” It’s best to have a professional that understands the finishing process and has experience with the different wood specie, stains, paints, and clear finishes. Always finish doors in a controlled environment—dust free, temperature and humidity controlled—and finish within a few days of receiving them. Morgan Bros. is not responsible for the finishing process. Understanding the finishing process and the result is the customer’s responsibility.

NOTE: *Solid wood and plywood veneers may take stain differently, lighter/darker. This may require additional stain to the solid wood or veneer.*

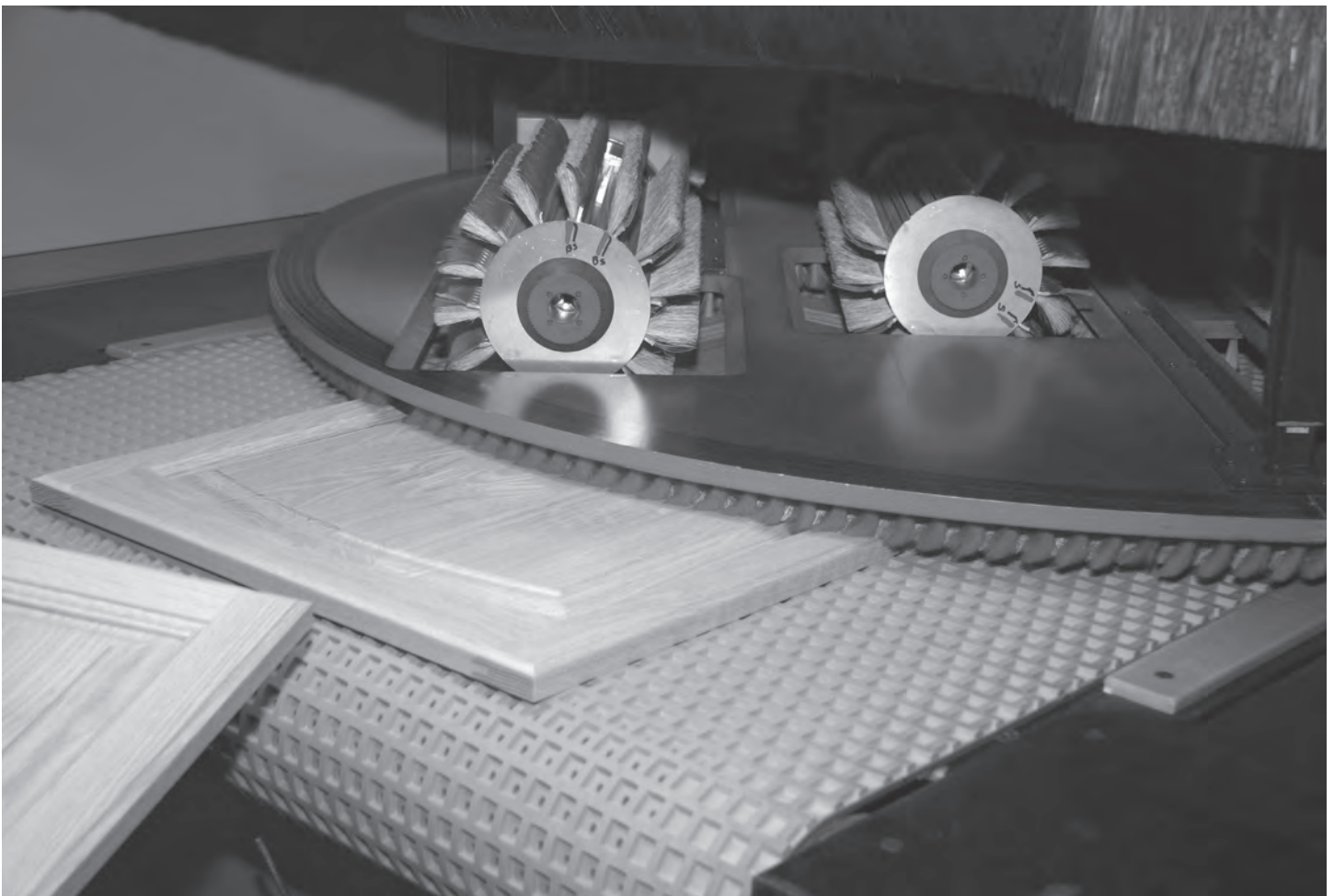

COPE & STICK • Rail & Stile Profiles

Standard

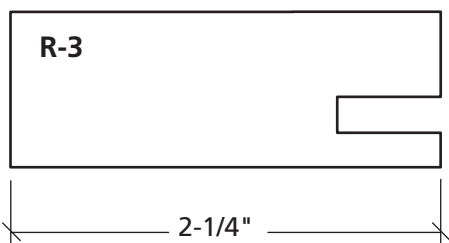
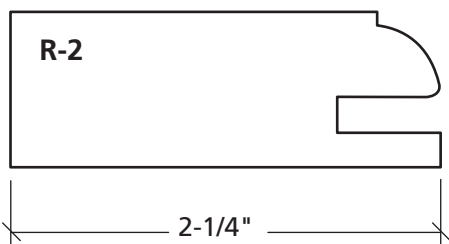
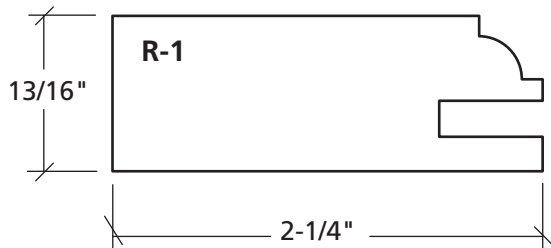

NOTE: The R-3 Rail Profile is not available with arch doors.

Classic Bold

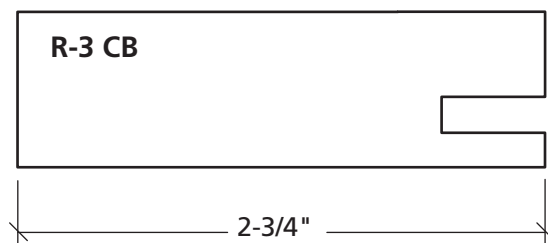
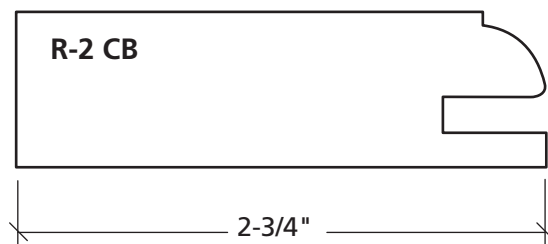
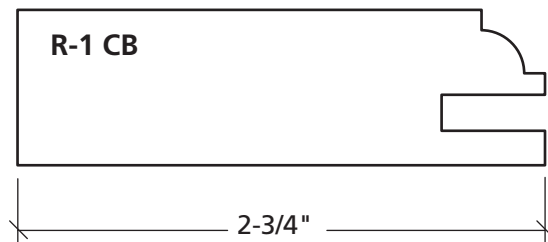

NOTE: With Classic Bold, minimum Door and Drawer Front measurements are increased by one inch width and one inch height.

Classic Bold Rail and Stile Profiles are run per order. Please allow a few extra days for delivery.

DOOR & DRAWER FRONT • Panel Profiles

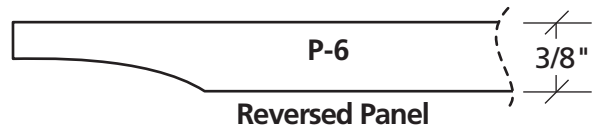
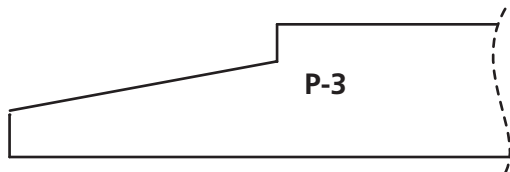
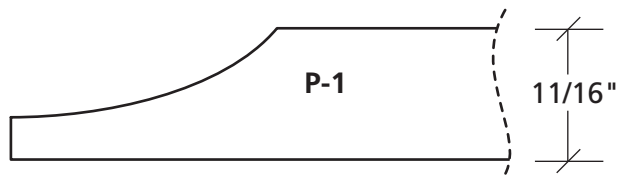

NOTE: Plywood panel doors and drawer fronts are 200 & 500 series only with all rail profiles

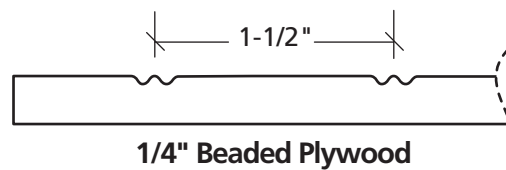

Available in Red Oak and Northern Soft Maple only

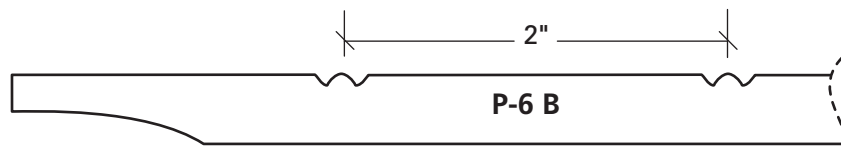

Reversed Solid Panel Beaded
Available in all wood species and MDF for paint.

EDGE PROFILES

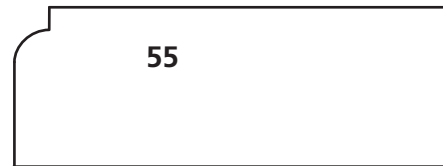
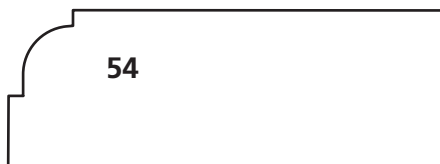
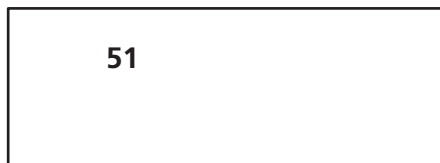
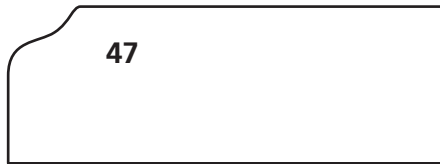

NOTE: Available on Rail Profiles R-1, R-2, R-3

DOOR STYLES • Solid Wood Raised Panel

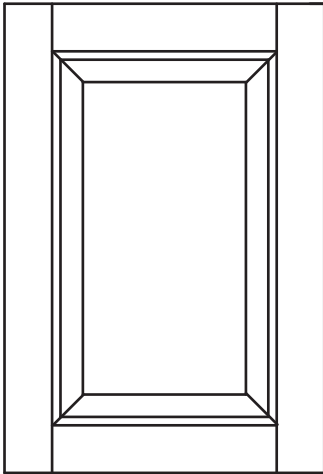

101 Square Raised Panel

Minimum Width: 7-3/4"
Minimum Height: 8"

- Solid Wood Raised Panel Doors also available with MDF Center Panel for Paint Grade.
- All 100 Series Cope & Stick Doors available with R-1 and R-2 Rail & Stile Profiles and P-1 through P-6B Panel Profiles
- Arched doors can be constructed smaller than their minimum widths, but will not have full arch effect.

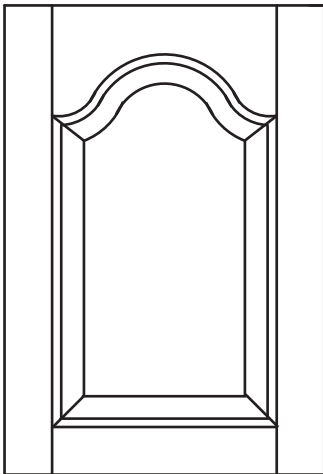

102 Cathedral Raised Panel

Minimum Width: 7-3/4"
Minimum Height: 9-1/2"

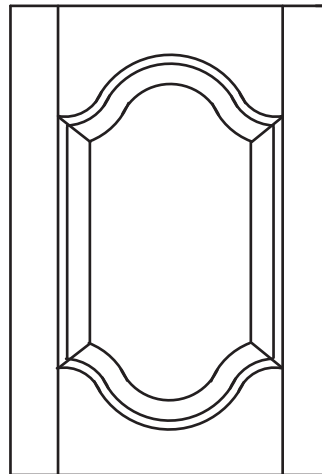

103 Double Cathedral Raised Panel

Minimum Width: 7-3/4"
Minimum Height: 12-1/4"

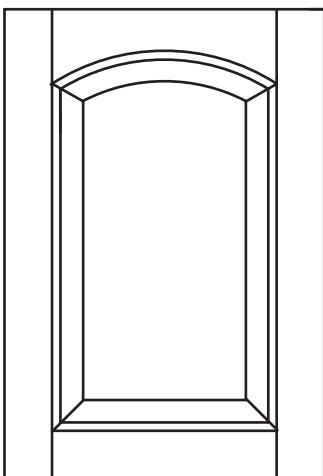

104 Eyebrow Raised Panel

Minimum Width: 7-3/4"
Minimum Height: 9-1/2"

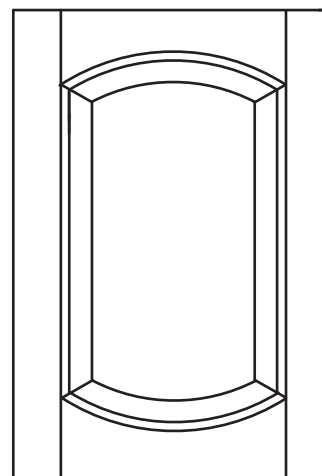

105 Double Eyebrow Raised Panel

Minimum Width: 7-3/4"
Minimum Height: 12-1/4"

DOOR STYLES • Solid Wood Raised Panel

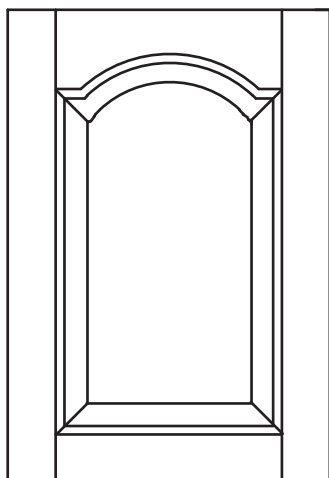

106 Shoulder Eyebrow Raised Panel

Minimum Width: 11-1/4"
Minimum Height: 9-1/2"

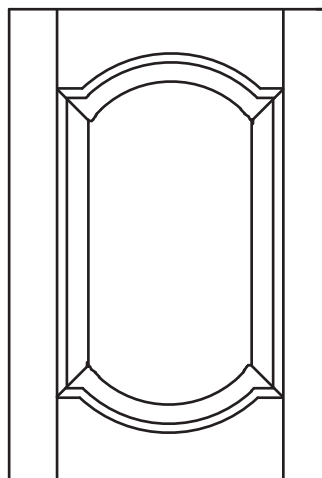

107 Double Shoulder Eyebrow Raised Panel

Minimum Width: 11-1/4"
Minimum Height: 12-1/4"

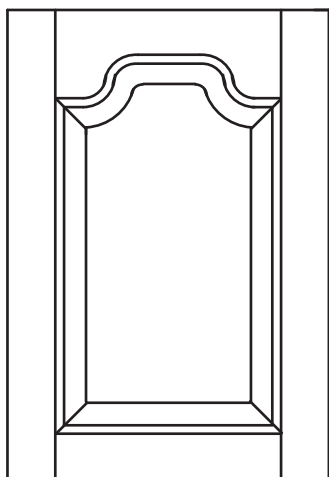

108 Flattop Raised Panel

Minimum Width: 13-1/4"
Minimum Height: 9-1/2"

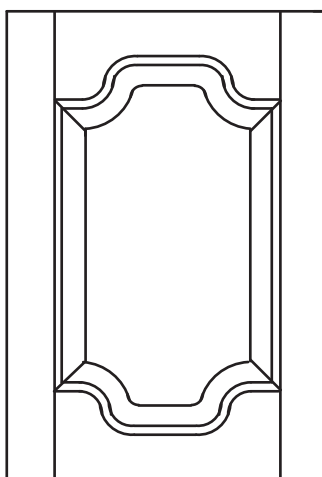

109 Double Flattop Raised Panel

Minimum Width: 13-1/4"
Minimum Height: 12-1/4"

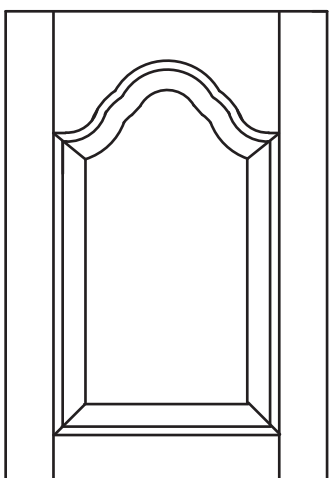

110 Teardrop Raised Panel

Minimum Width: 13-1/4"
Minimum Height: 11"

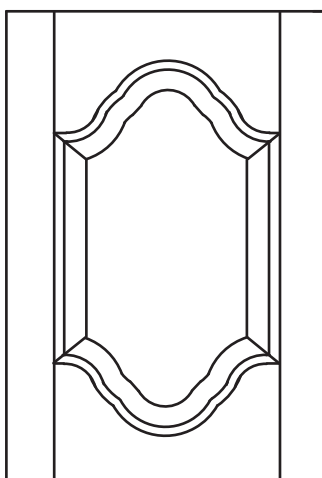

111 Double Teardrop Raised Panel

Minimum Width: 13-1/4"
Minimum Height: 13-3/4"

DOOR STYLES • Solid Wood Rails - 1/4" Plywood Panels

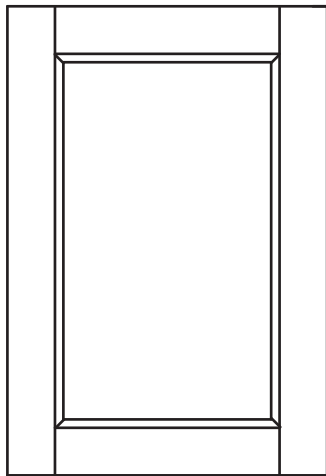

201 Square Flat Panel

Minimum Width: 7-3/4"
Minimum Height: 6"

NOTE: 200 Series Doors come with R-1 or R-2 Profiles.

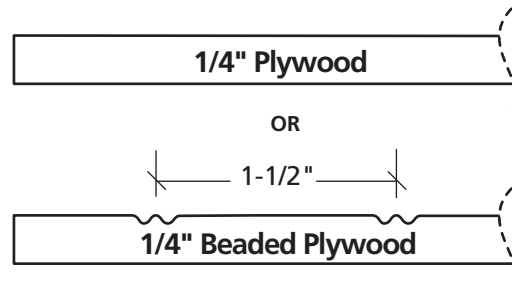

1/4" Beaded plywood is available in Red Oak and Maple only, on all 1/4" plywood panel doors. When ordering place a (B) at the end of door number (example 201B).

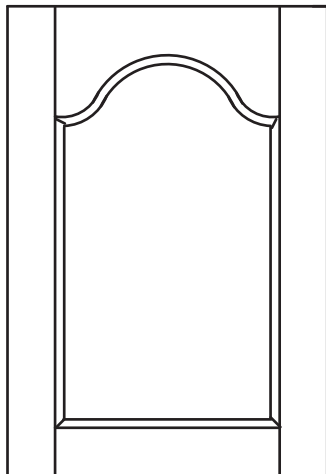

202 Cathedral Flat Panel

Minimum Width: 7-3/4"
Minimum Height: 8"

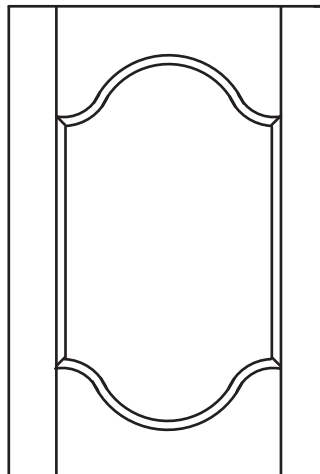

203 Double Cathedral Flat Panel

Minimum Width: 7-3/4"
Minimum Height: 12"

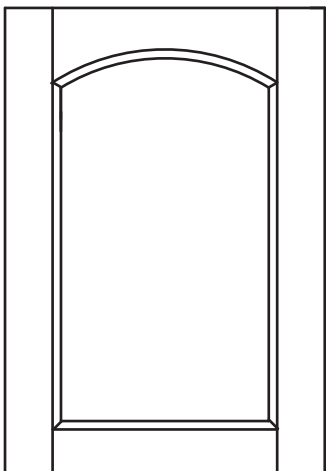

204 Eyebrow Flat Panel

Minimum Width: 7-3/4"
Minimum Height: 8"

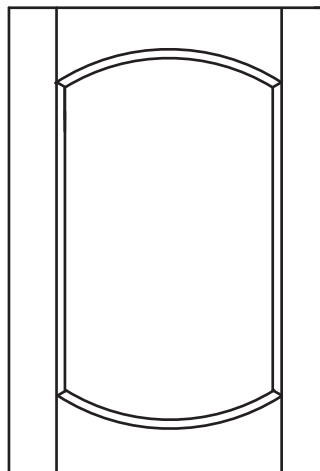

205 Double Eyebrow Flat Panel

Minimum Width: 7-3/4"
Minimum Height: 12"

DOOR STYLES • Solid Wood Rails - 1/4" Plywood Panels

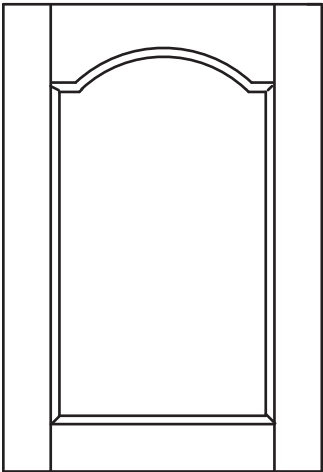

206 Shoulder Eyebrow Flat Panel

Minimum Width: 11-1/4"
Minimum Height: 8"

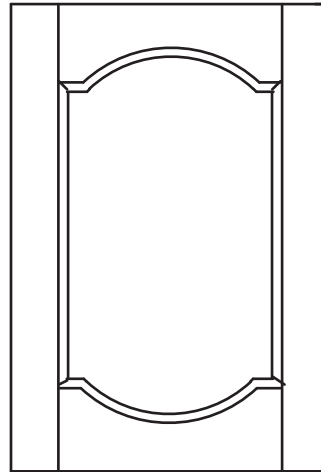

207 Double Shoulder Eyebrow Flat Panel

Minimum Width: 11-1/4"
Minimum Height: 12"

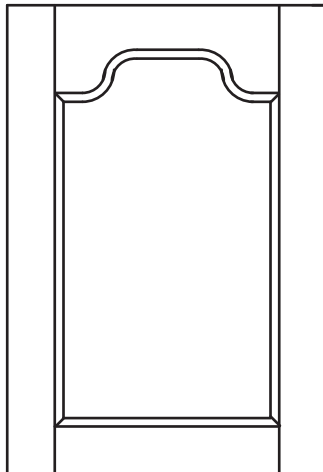

208 Flattop Flat Panel

Minimum Width: 13-1/4"
Minimum Height: 8"

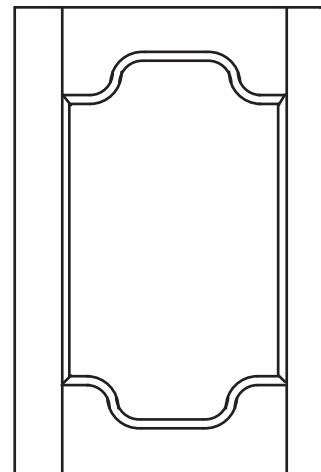

209 Double Flattop Flat Panel

Minimum Width: 13-1/4"
Minimum Height: 12"

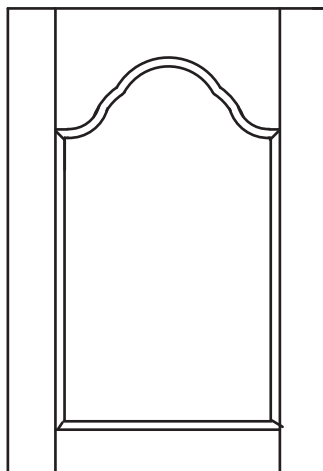

210 Teardrop Flat Panel

Minimum Width: 13-1/4"
Minimum Height: 11"

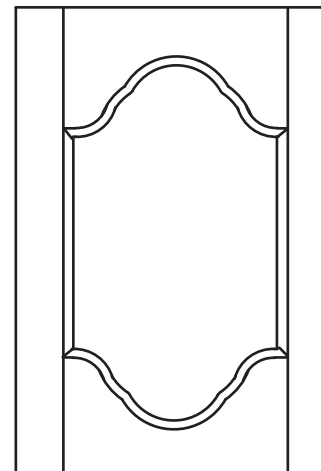

211 Double Teardrop Flat Panel

Minimum Width: 13-1/4"
Minimum Height: 13-3/4"

DOOR STYLES • Shaker Series Solid Wood Raised Panel

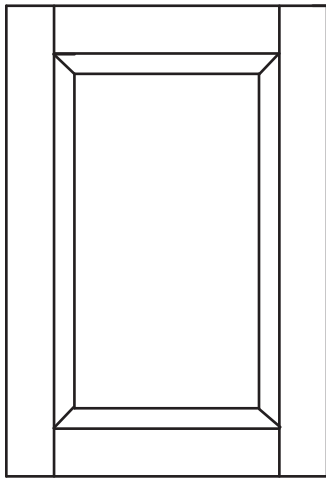

701 Square Raised Solid Panel

Minimum Width: 7-3/4"
Minimum Height: 8"

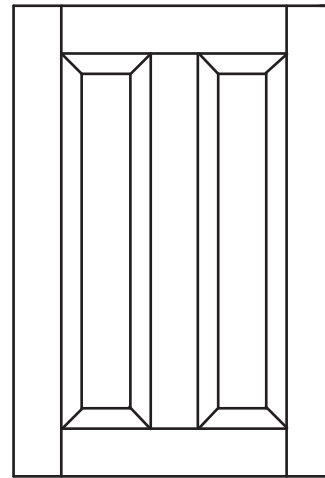

701X Square Double Vertical Raised Solid Panel

Minimum Width: 13-1/4"
Minimum Height: 8"

- Shaker Series Solid Wood Raised Panel Doors also available with MDF Center Panel for Paint Grade.

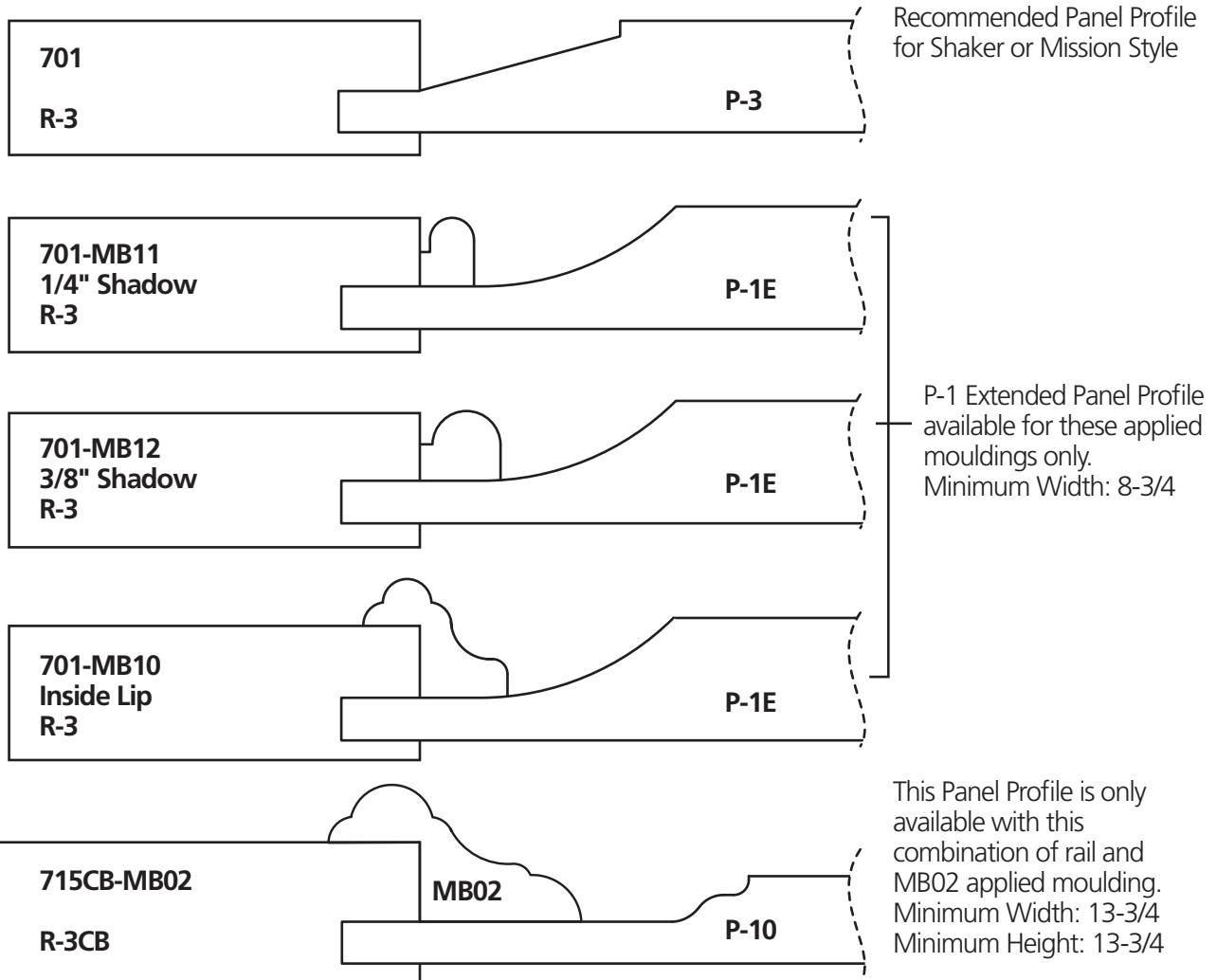

We recommend a 51 or 53 Edge Profile. See page 11 for edge profiles.

DOOR STYLES • Shaker Series Solid Wood Reversed Panel

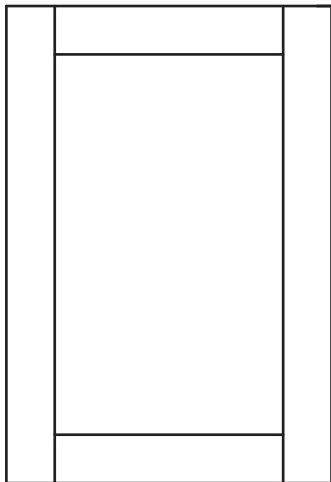

701 Square Reversed Solid Panel

Minimum Width: 7-3/4"
Minimum Height: 8"

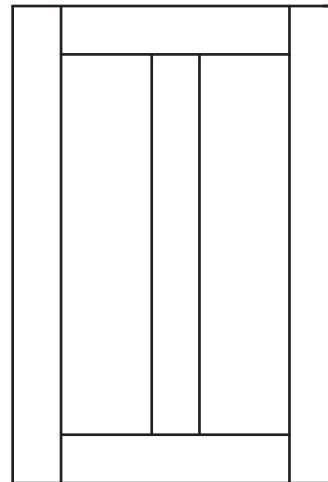

701X Square Double Vertical Reversed Solid Panel

Minimum Width: 13-1/4"
Minimum Height: 8"

- Shaker Series Solid Wood Reversed Panel Doors also available with MDF Center Panel for Paint Grade.

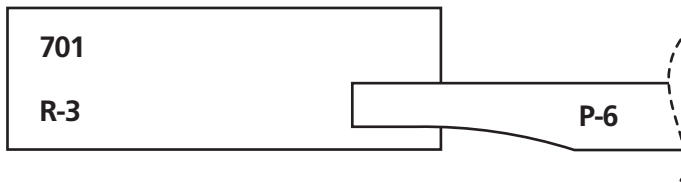

NOTE: 700 Series Doors come with R-3 Rail & Stile Profile

- The following applied mouldings are offered on Shaker Reversed Solid Wood Panel Doors

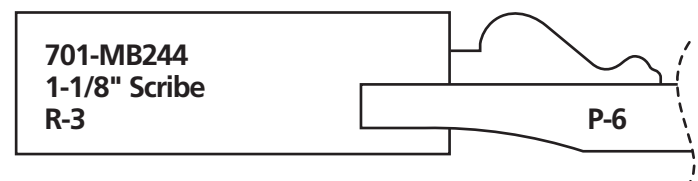
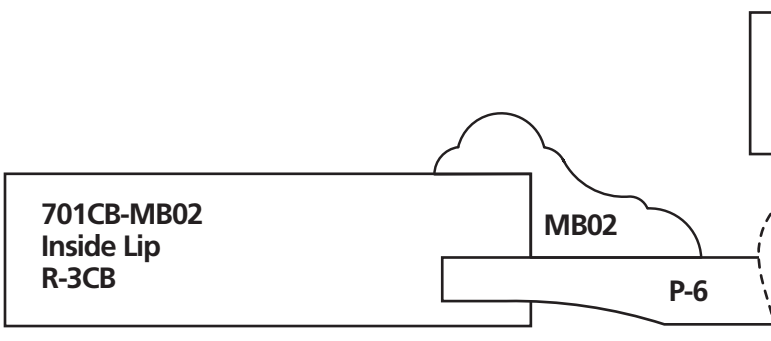
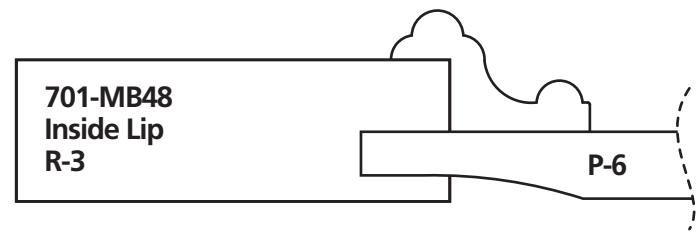
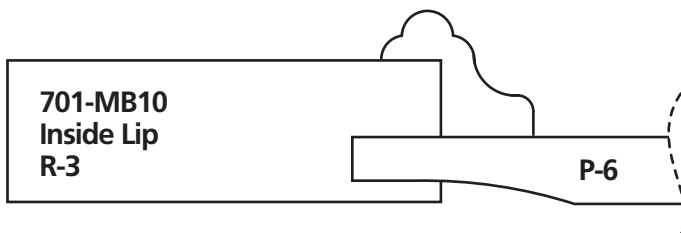
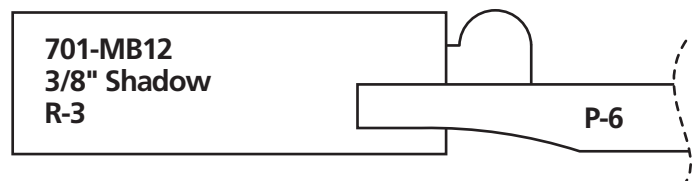
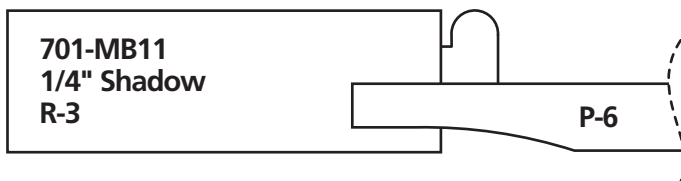

Available with 2-3/4" Rail & Stile only.
Minimum Width: 9-1/2"
Minimum Height: 9-1/2"

DOOR STYLES • Shaker Series - 1/4" Plywood Panels

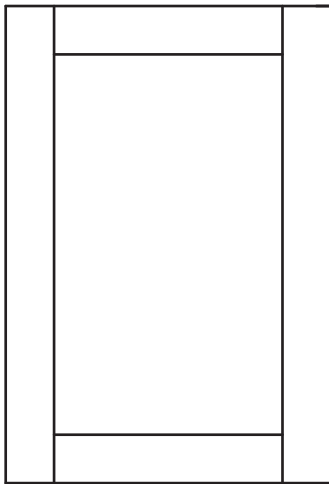

501 Square Flat Panel

Minimum Width: 7-3/4"
Minimum Height: 8"

NOTE: 500 Series Doors come with R-3 Rail & Stile Profile only.

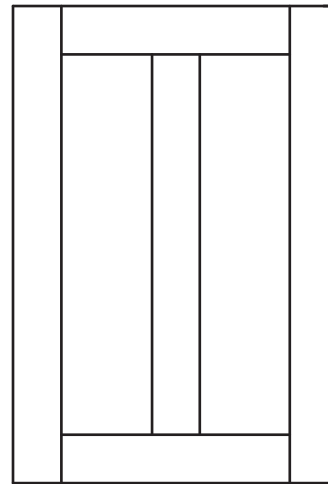

501X Square Double Vertical Flat Panel

Minimum Width: 13-1/4"
Minimum Height: 8"

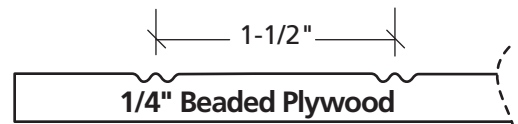
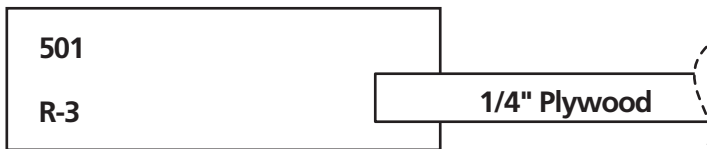

NOTE: See page 14 NOTE on 1/4" Plywood

• The following applied mouldings are offered on Shaker Flat Panel Doors

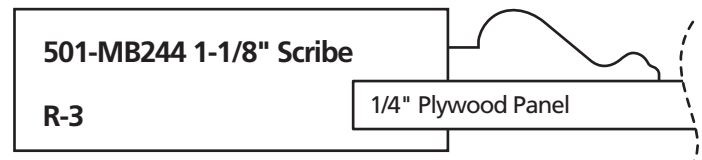
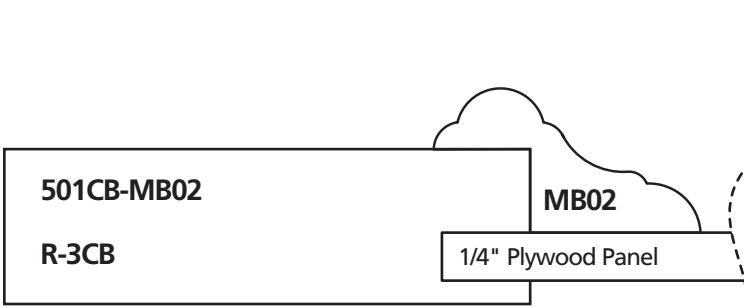
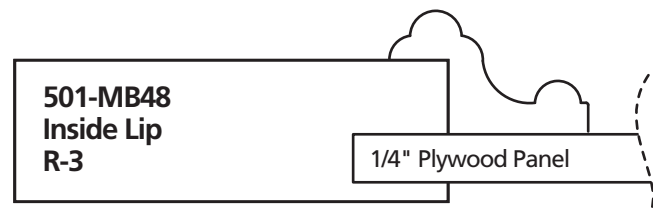
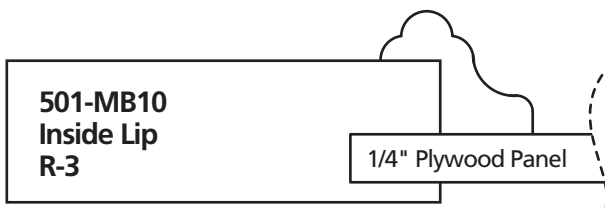
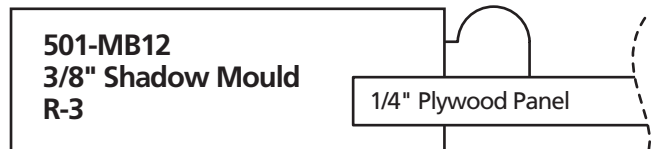
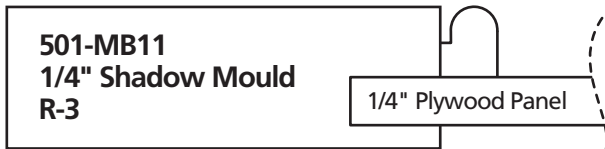

DOOR STYLES • Mitered Corner Solid Wood Raised Panel

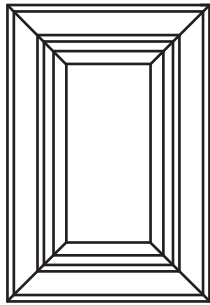

145 Square Raised Panel

Minimum Width: 9-1/2"
Minimum Height: 9-1/2"

- Solid Wood Raised Panel Doors also available with MDF Center Panel for Paint Grade.
- All 100 Series Doors available with P-6 Panel Profiles

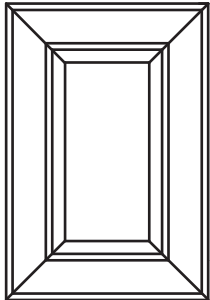
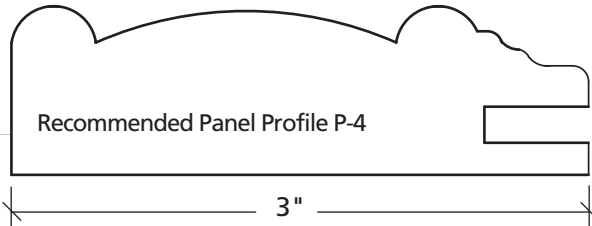

146 Square Raised Panel

Minimum Width: 8-1/2"
Minimum Height: 8-1/2"

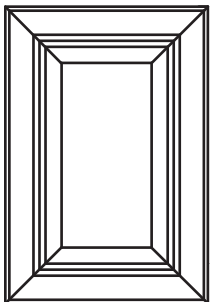
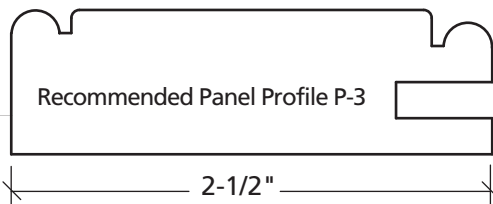

147 Square Raised Panel

Minimum Width: 8-1/2"
Minimum Height: 8-1/2"

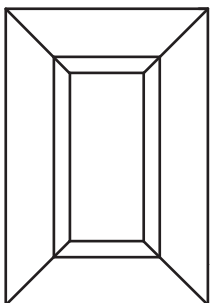
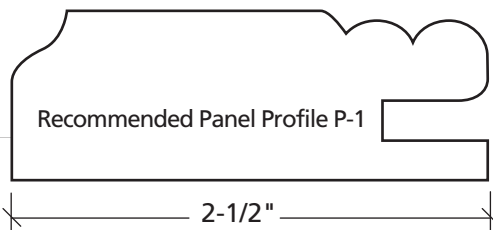

149 Square Raised Panel

Minimum Width: 9-1/2"
Minimum Height: 9-1/2"

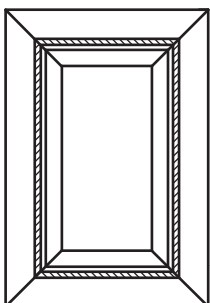
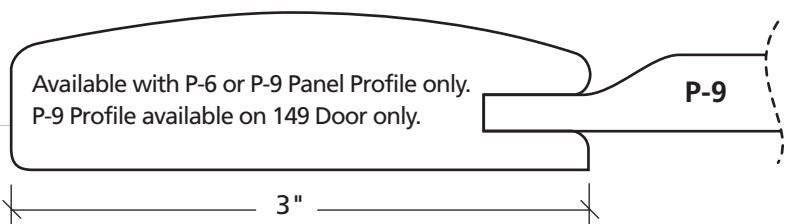

150 Square Raised Panel

Minimum Width: 8-1/2"
Minimum Height: 8-1/2"

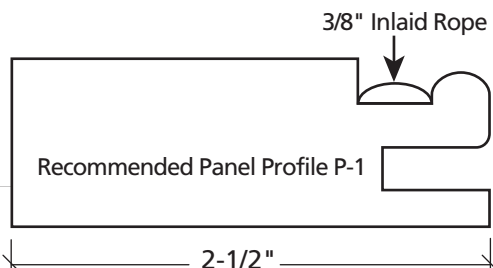

These Doors are only available in Alder, Cherry, Hard Maple, Soft Maple, Red Oak, and Ash.

DOOR STYLES • Mitered Corner - 1/4" Plywood Panels

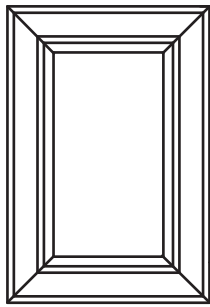

245 Square Flat Panel

Minimum Width: 8"
Minimum Height: 8"

1/4" Beaded plywood is available in Red Oak and Maple only, on all 1/4" plywood panel doors. When ordering place a (B) at the end of door number (example 201B).

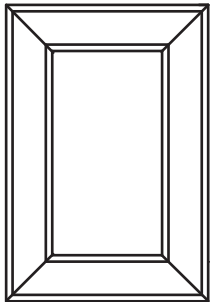
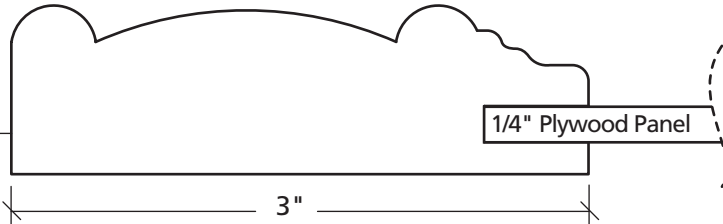

246 Square Flat Panel

Minimum Width: 7"
Minimum Height: 7"

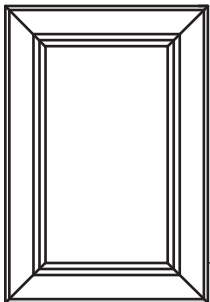
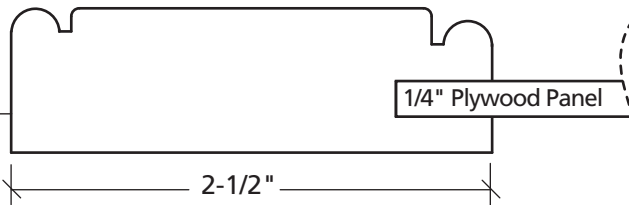

247 Square Flat Panel

Minimum Width: 7"
Minimum Height: 7"

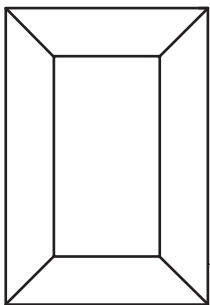
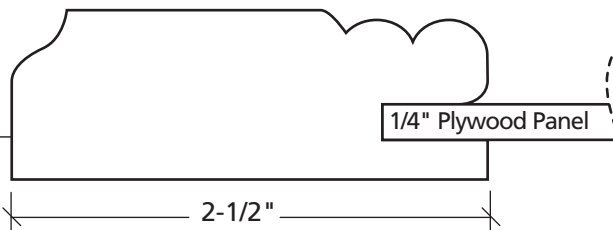

249 Square Flat Panel

Minimum Width: 8"
Minimum Height: 8"

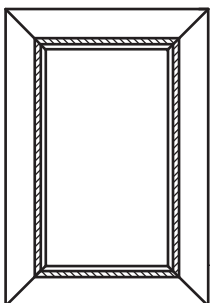
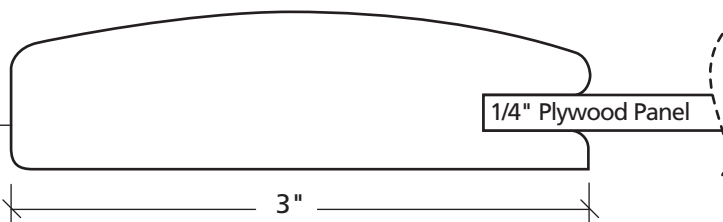

250 Square Flat Panel

Minimum Width: 7"
Minimum Height: 7"

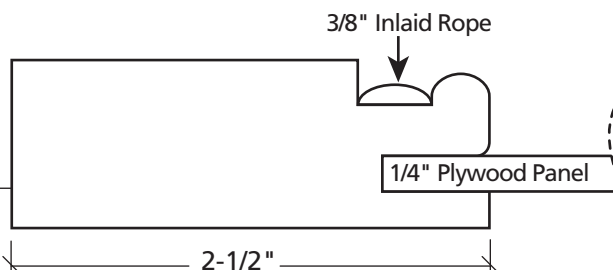

These Doors are only available in Alder, Cherry, Hard Maple, Soft Maple, Red Oak, and Ash.

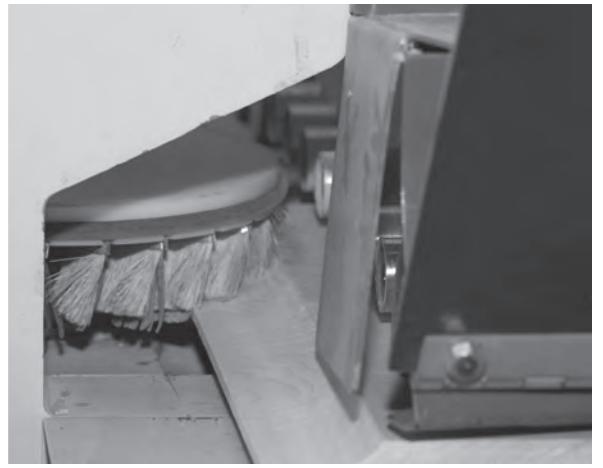
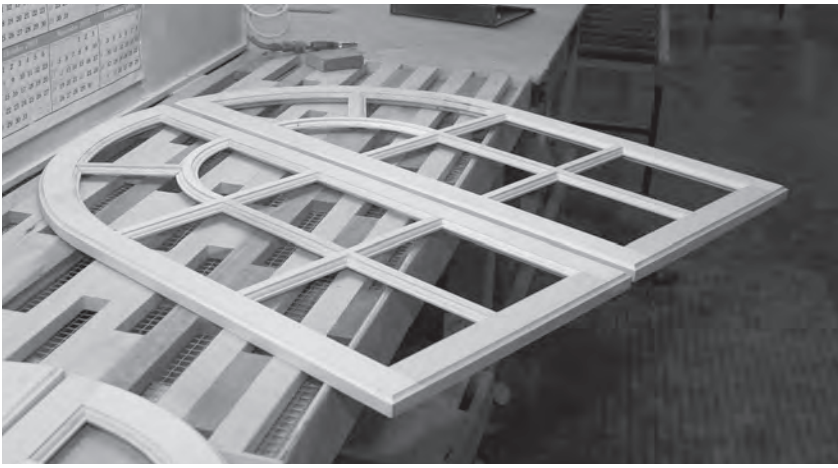

DOOR STYLES • Solid Wood Rails - Glass Panels

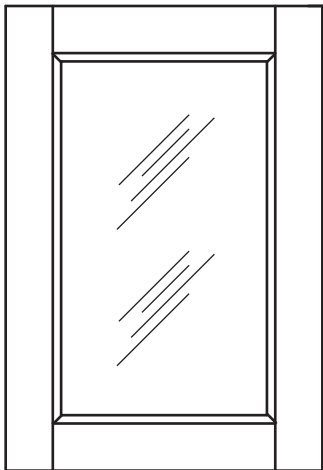

201 GL Square Glass Panel

Minimum Width: 7-3/4"
Minimum Height: 6"

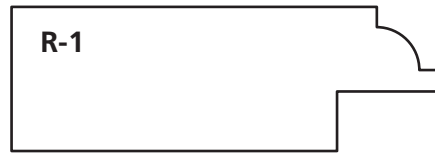

* Glass supplied by customer

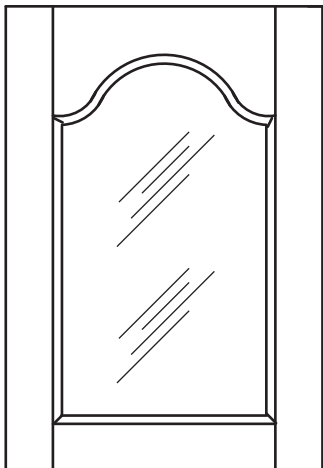

202GL Cathedral Glass Panel

Minimum Width: 7-3/4"
Minimum Height: 8"

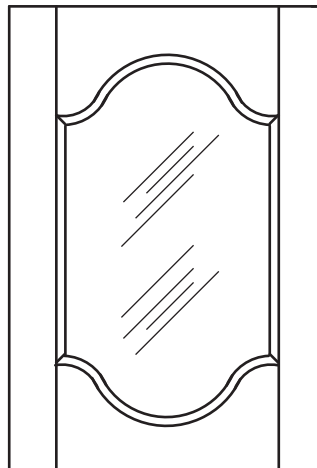

203GL Double Cathedral Glass Panel

Minimum Width: 7-3/4"
Minimum Height: 12"

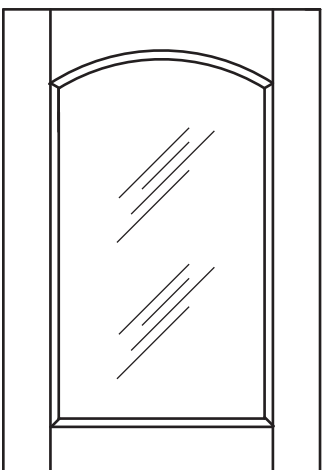

204GL Eyebrow Glass Panel

Minimum Width: 7-3/4"
Minimum Height: 8"

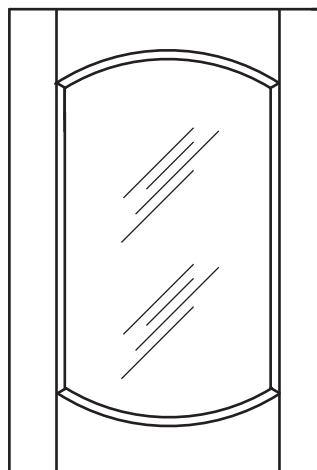

205GL Double Eyebrow Glass Panel

Minimum Width: 7-3/4"
Minimum Height: 12"

DOOR STYLES • Solid Wood Rails - Glass Panels

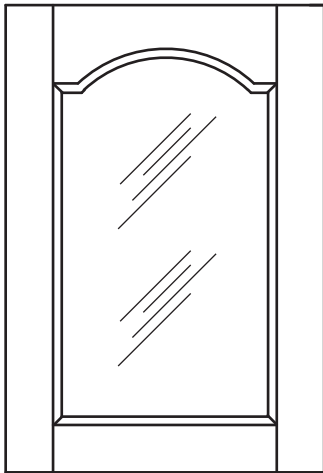

206GL Shoulder Eyebrow Glass Panel

Minimum Width: 11-1/4"
Minimum Height: 8"

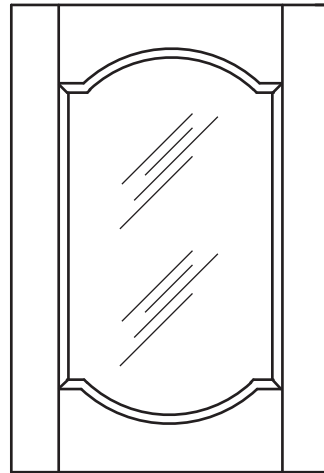

207 Double Shoulder Eyebrow Glass Panel

Minimum Width: 11-1/4"
Minimum Height: 12"

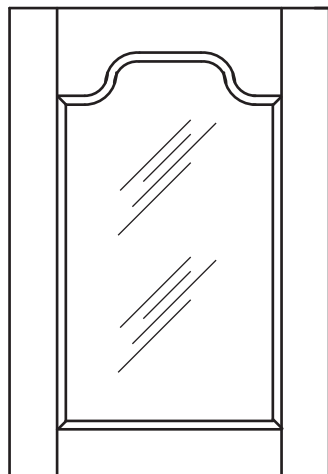

208GL Flattop Glass Panel

Minimum Width: 13-1/4"
Minimum Height: 8"

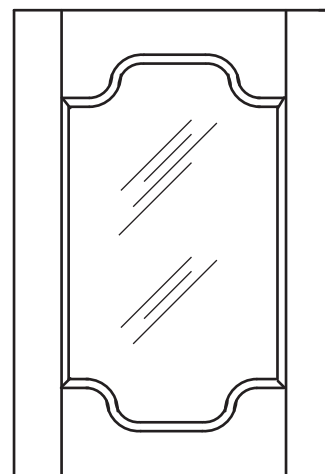

209GL Double Flattop Glass Panel

Minimum Width: 13-1/4"
Minimum Height: 12"

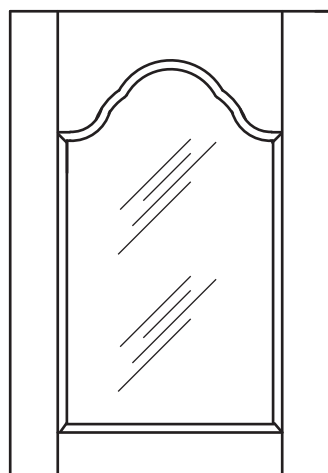

210GL Teardrop Glass Panel

Minimum Width: 13-1/4"
Minimum Height: 11"

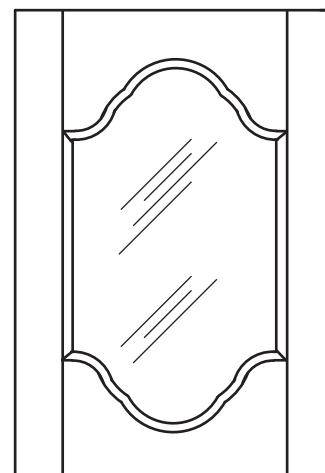

211GL Double Teardrop Glass Panel

Minimum Width: 13-1/4"
Minimum Height: 13-3/4"

* Glass supplied by customer

GRID PATTERNS • Solid Wood Rails - For 200 Series Cope & Stick Glass Doors - Fixed Grid

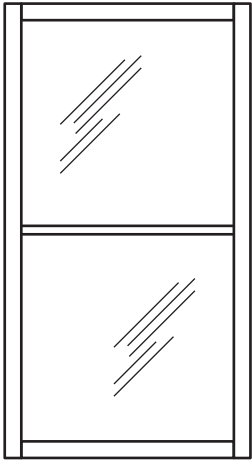
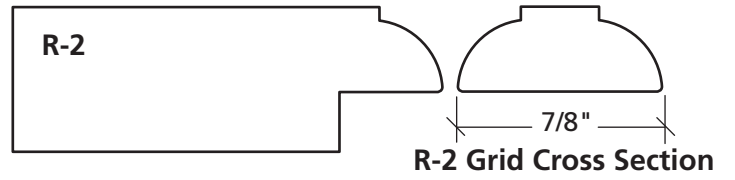
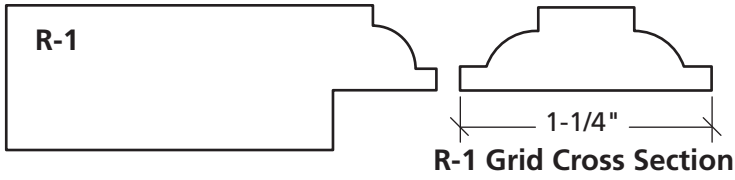

GL 2 Lite

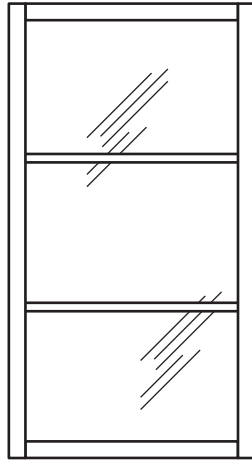

GL 3 Lite

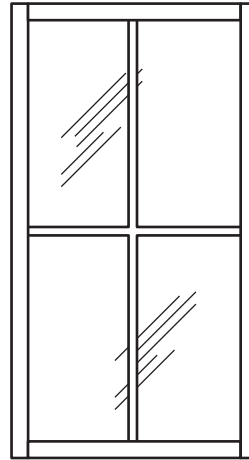

GL 4 Lite

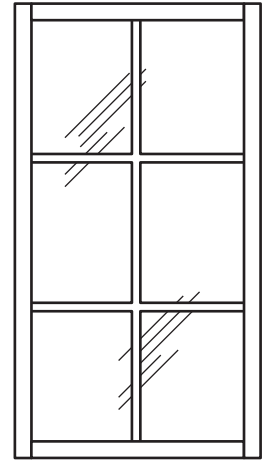

GL 6 Lite

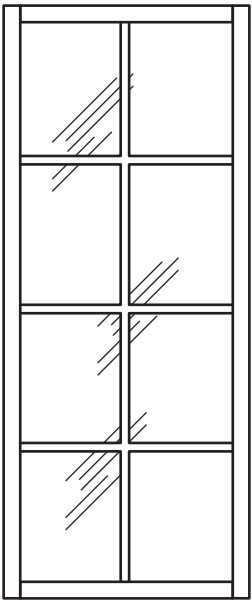

GL 8 Lite

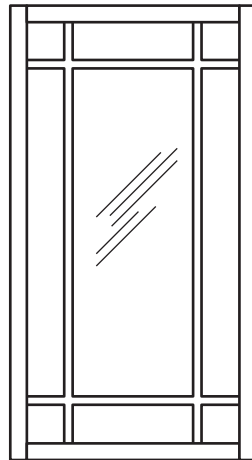

GL 9 Lite

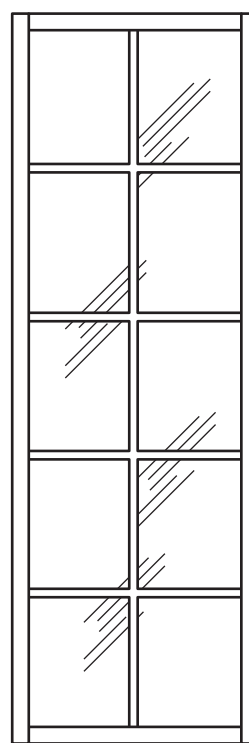

GL 10 Lite

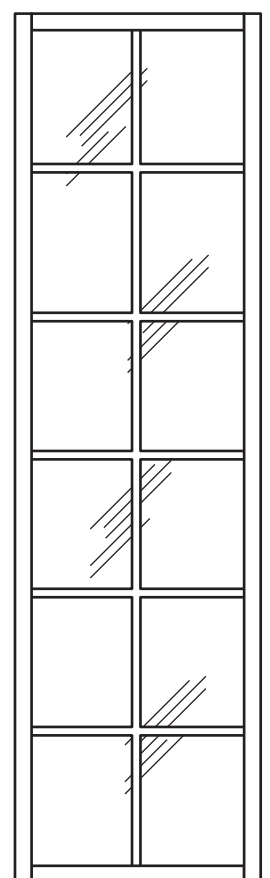

GL 12 Lite

* Glass supplied by customer

DOOR STYLES • Shaker Series - Glass Panels - Loose Grid

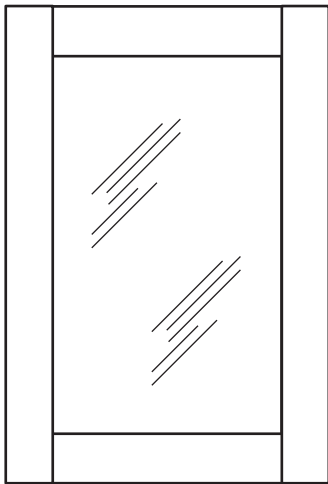

501GL Square Glass Panel

Minimum Width: 7-1/2"
Minimum Height: 6"

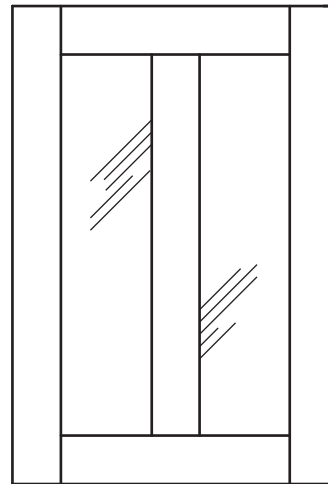

501XGL Square Double Vertical Glass Panel

Minimum Width: 10-3/4"
Minimum Height: 7-1/2"

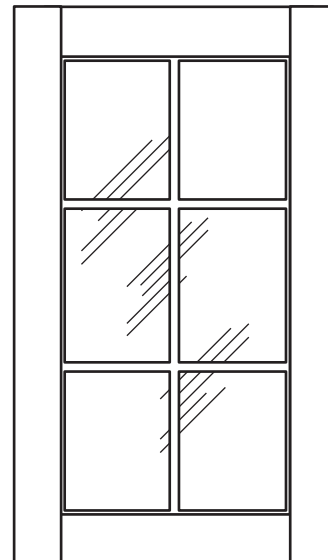
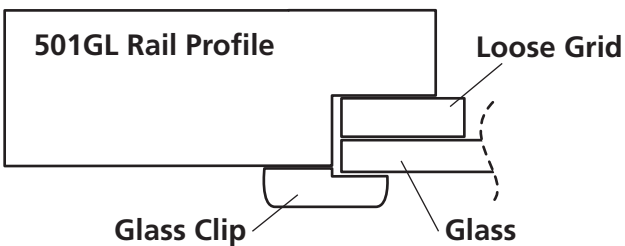
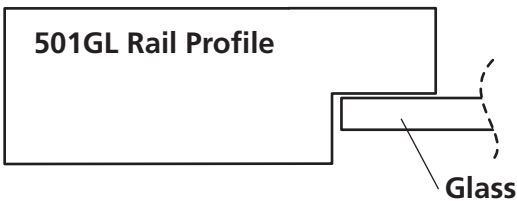

501GL 6 Lite (Example)

Available in 2, 3, 4, 6, 8, 9, 10 & 12 Lite Grid Patterns as seen on page 26.
Glass and Glass Clips supplied by customer.

GRID PATTERNS • 200 Series Glass Mitered Corner Doors Loose Grid

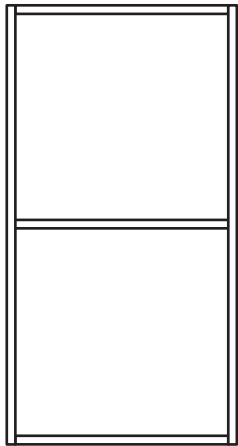

GL 2 Lite

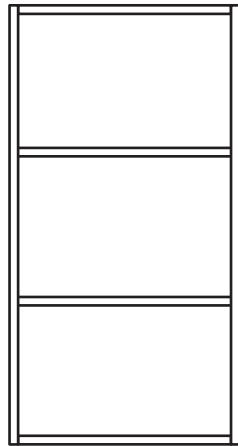

GL 3 Lite

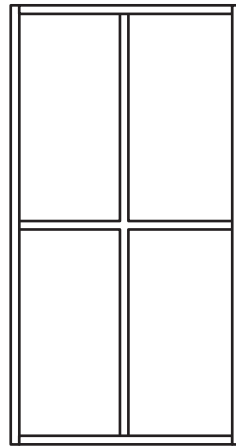

GL 4 Lite

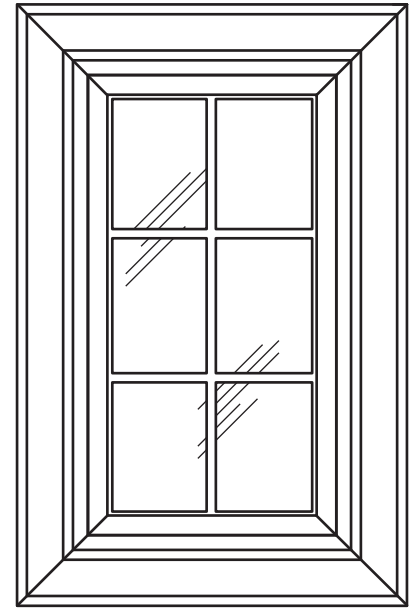

245GL 6 Lite (Example)

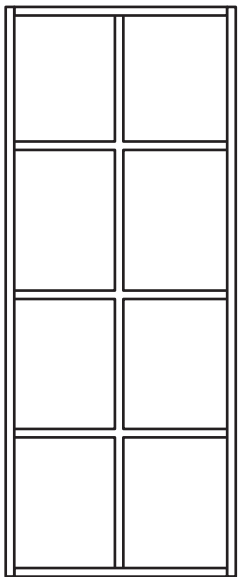

GL 8 Lite

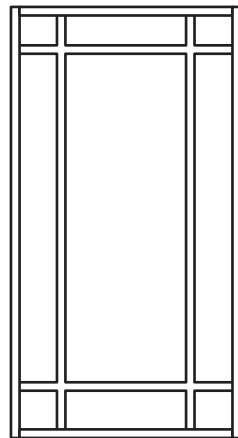

GL 9 Lite

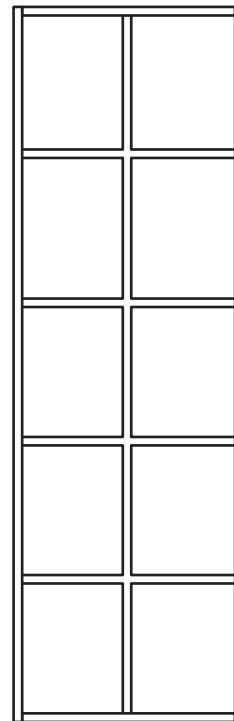

GL 10 Lite

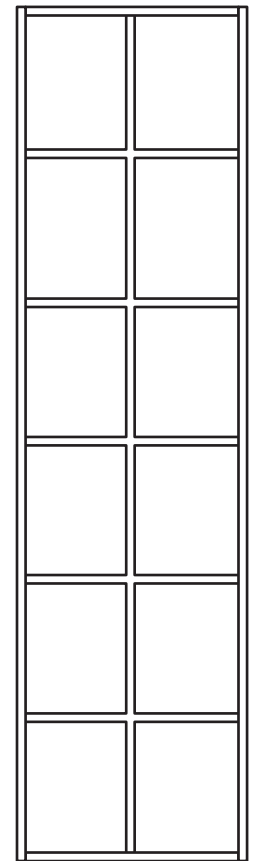

GL 12 Lite

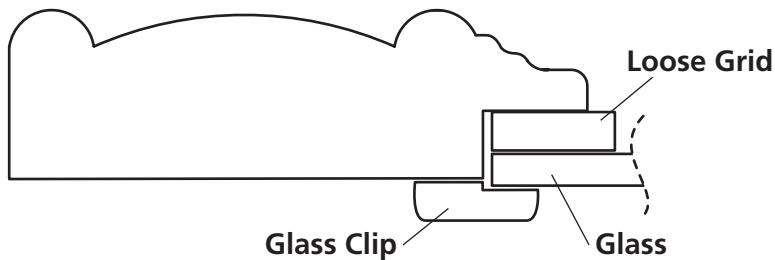

Glass and Glass Clips supplied by customer

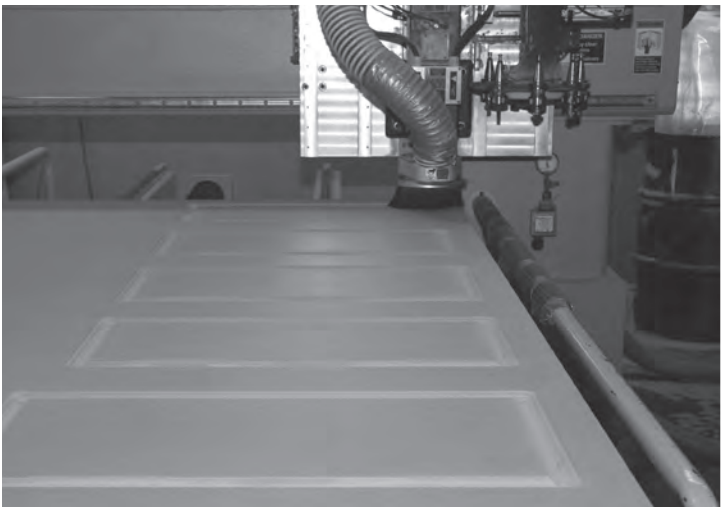
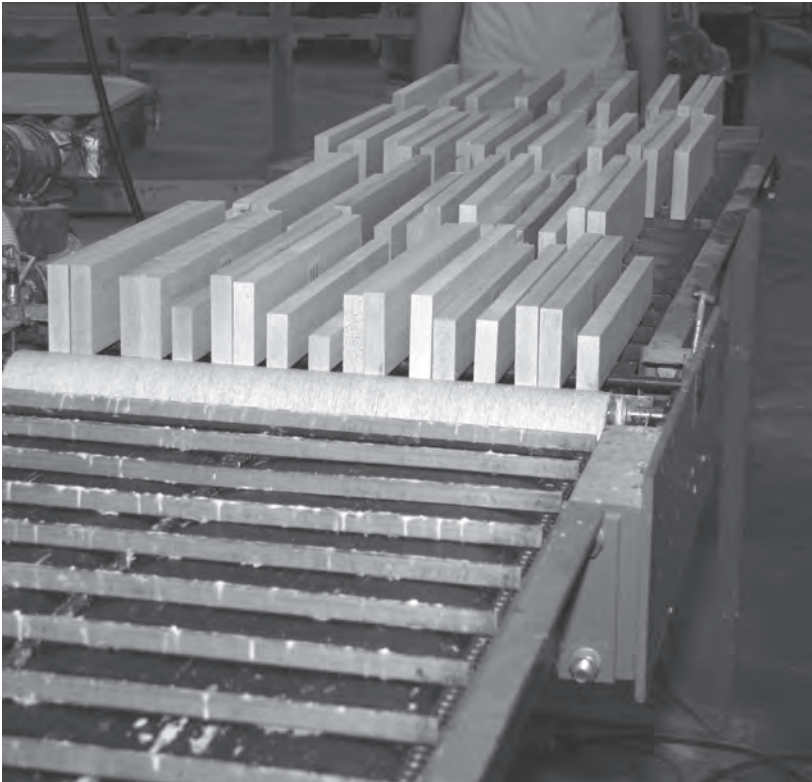

DOOR STYLES • Raw MDF - Raised Panel - One Piece Door

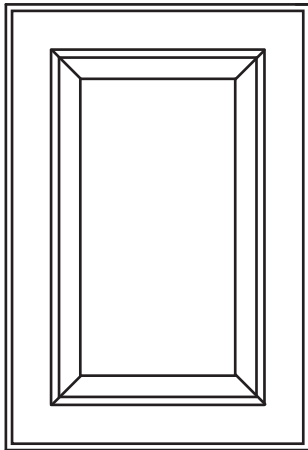

401-MDF Square Raised Panel

Minimum Width: 8"
Minimum Height: 8"

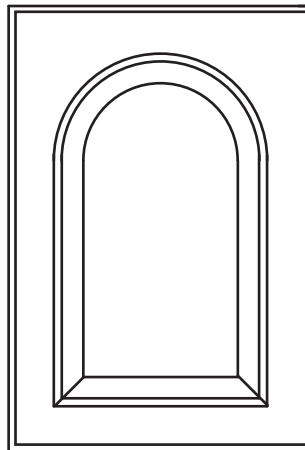

406-MDF Full Arch Raised Panel

Minimum Width: 9"
Minimum Height: 12"

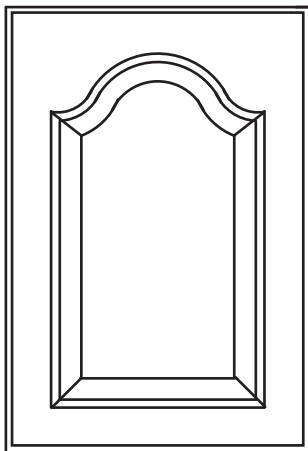

402-MDF Cathedral Raised Panel

Minimum Width: 10 13/16"
Minimum Height: 10"

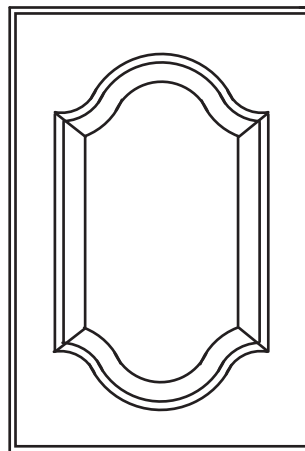

403-MDF Double Cathedral Raised Panel

Minimum Width: 10 13/16"
Minimum Height: 12"

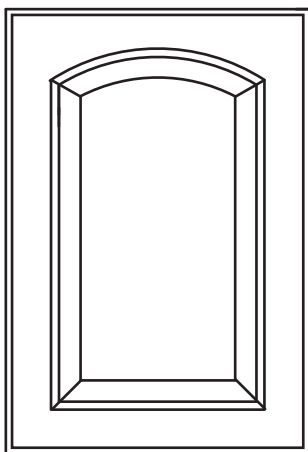

404-MDF Eyebrow Raised Panel

Minimum Width: 8"
Minimum Height: 10"

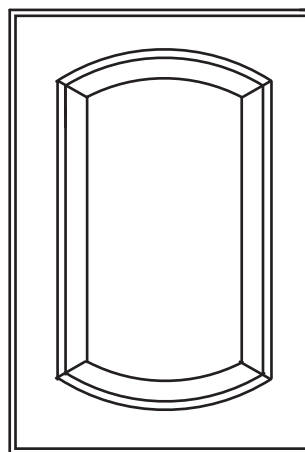

405-MDF Double Eyebrow Raised Panel

Minimum Width: 8"
Minimum Height: 12"

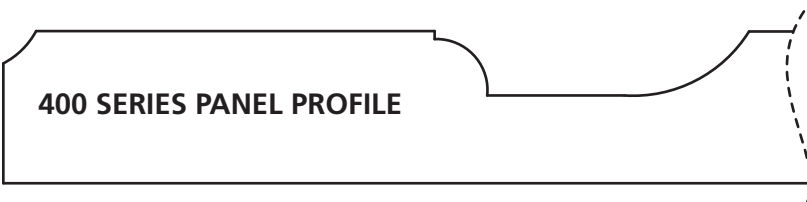

400 SERIES PANEL PROFILE

- * Raw MDF is a paintable material only.
- * Available with 52 edge profile only.

DOOR STYLES • Raw MDF - Glass Panel

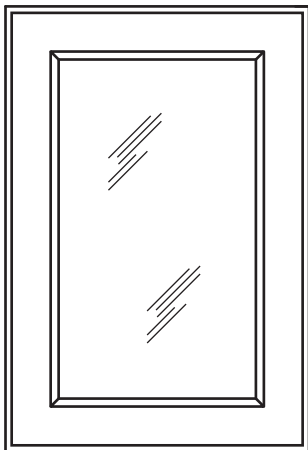

401GL
MDF Square
Glass Panel

Minimum Width: 8"
Minimum Height: 8"

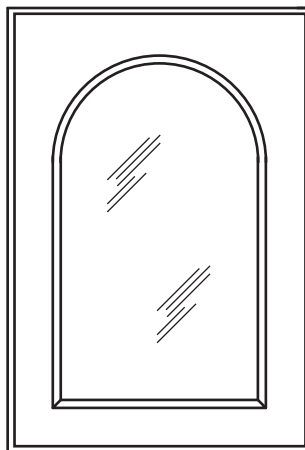

406GL
MDF Full Arch
Glass Panel

Minimum Width: 9"
Minimum Height: 12"

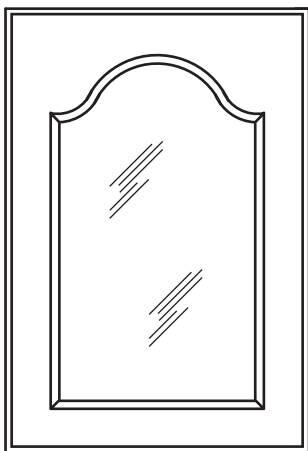

402GL
MDF Cathedral
Glass Panel

Minimum Width: 10 13/16"
Minimum Height: 10"

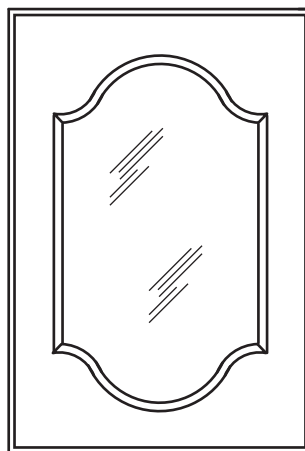

403GL
MDF Double Cathedral
Glass Panel

Minimum Width: 10 13/16"
Minimum Height: 12"

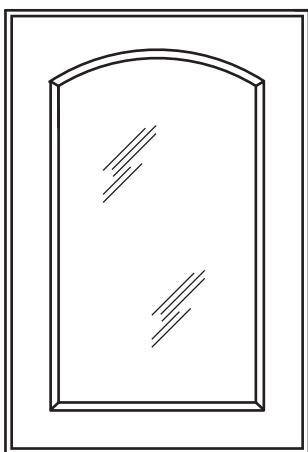

404GL
MDF Eyebrow
Glass Panel

Minimum Width: 8"
Minimum Height: 10"

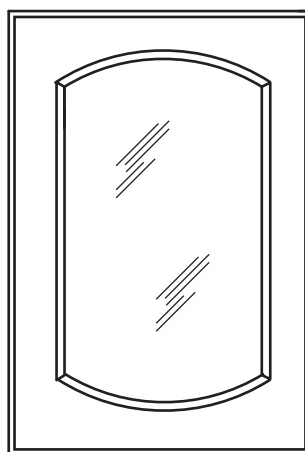

405GL
MDF Double Eyebrow
Glass Panel

Minimum Width: 8"
Minimum Height: 12"

- * Glass and glass clips supplied by customer
- * Raw MDF is a paintable material only.
- * Available with 52 edge profile only.

DOOR STYLES • Raw MDF - Raised Panel - One Piece Door

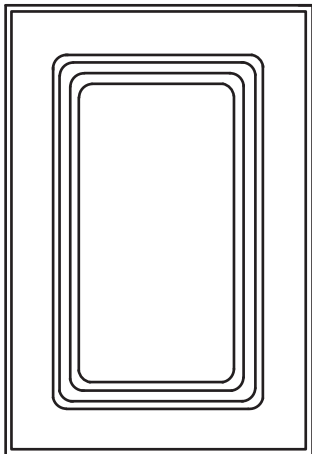

301-MDF Square Raised Panel

Minimum Width: 8"
Minimum Height: 8"

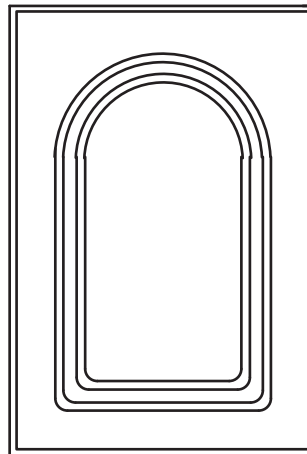

306-MDF Full Arch Raised Panel

Minimum Width: 9"
Minimum Height: 12"

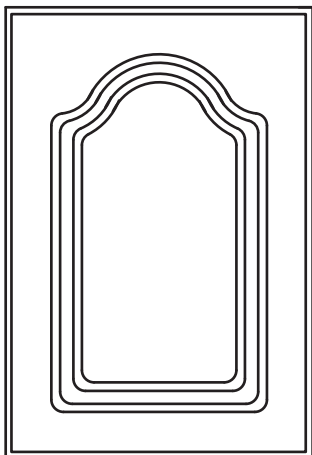

302-MDF Cathedral Raised Panel

Minimum Width: 11 3/8"
Minimum Height: 10"

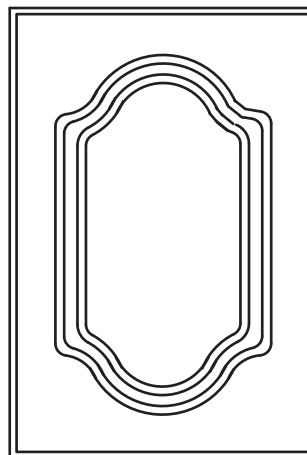

303-MDF Double Cathedral Raised Panel

Minimum Width: 11 3/8"
Minimum Height: 12"

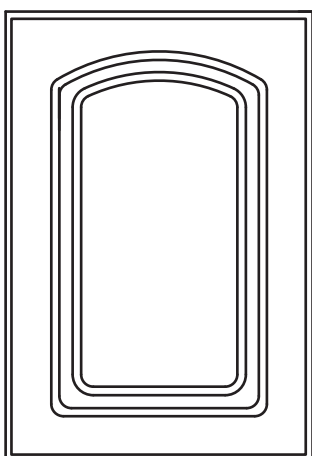

304-MDF Eyebrow Raised Panel

Minimum Width: 8"
Minimum Height: 10"

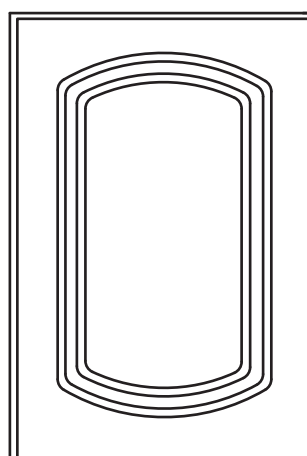

305-MDF Double Eyebrow Raised Panel

Minimum Width: 8"
Minimum Height: 12"



300 SERIES PANEL PROFILE

- * Raw MDF is a paintable material only.
- * Available with 52 edge profile only.

DOOR STYLES • Raw MDF - Glass Panel

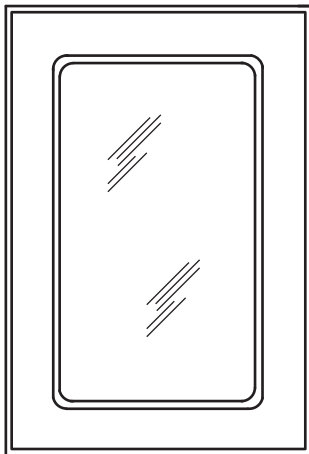

301GL
MDF Square
Glass Panel

Minimum Width: 8"
Minimum Height: 8"

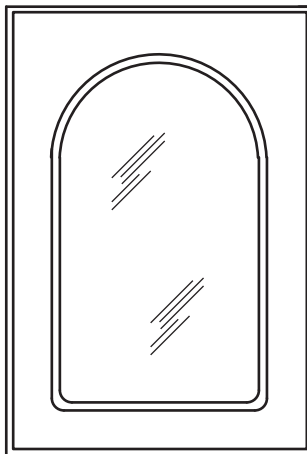

306GL
MDF Full Arch
Glass Panel

Minimum Width: 9"
Minimum Height: 12"

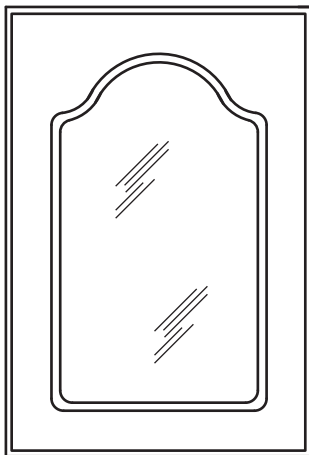

302GL
MDF Cathedral
Glass Panel

Minimum Width: 11 3/8"
Minimum Height: 10"

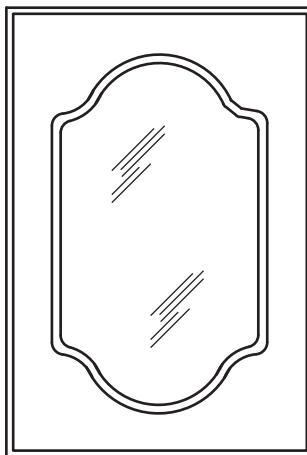

303GL
MDF Double Cathedral
Glass Panel

Minimum Width: 11 3/8"
Minimum Height: 12"

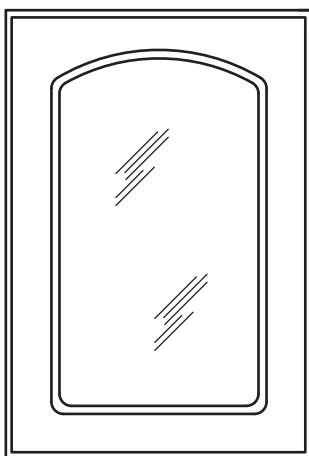

304GL
MDF Eyebrow
Glass Panel

Minimum Width: 8"
Minimum Height: 10"

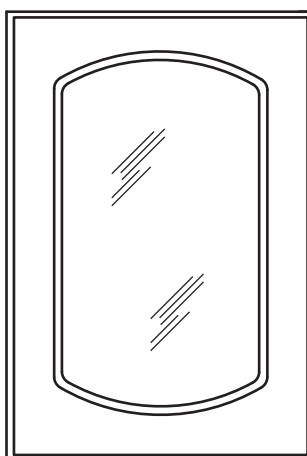

305GL
MDF Double Eyebrow
Glass Panel

Minimum Width: 8"
Minimum Height: 12"

- * Glass and glass clips supplied by customer
- * Raw MDF is a paintable material only.
- * Available with 52 edge profile only.

GRID PATTERNS • MDF Glass Doors

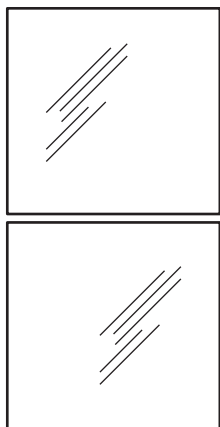

GL 2 Lite
Minimum width 8"
Minimum height 20"



GL 3 Lite
Minimum width 8"
Minimum height 28"

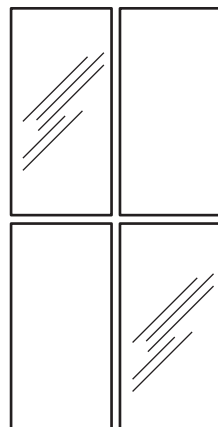

GL 4 Lite
Minimum width 12"
Minimum height 20"

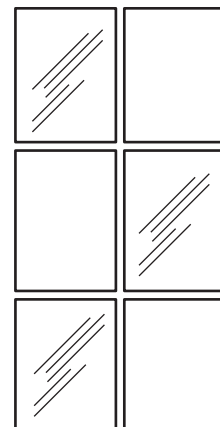

GL 6 Lite
Minimum width 12"
Minimum height 28"

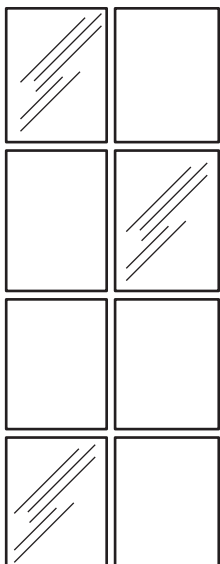

GL 8 Lite
Minimum width 12"
Minimum height 36"

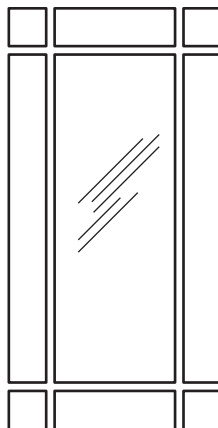

GL 9 Lite
Minimum width 15"
Minimum height 22"

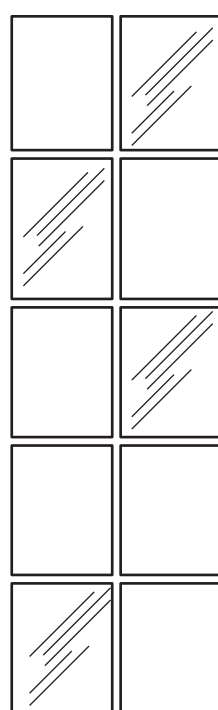

GL 10 Lite
Minimum width 12"
Minimum height 44"

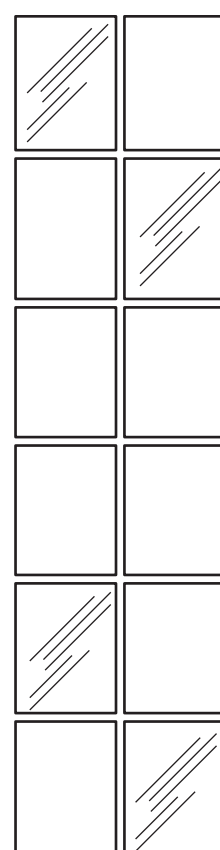

GL 12 Lite
Minimum width 12"
Minimum height 52"

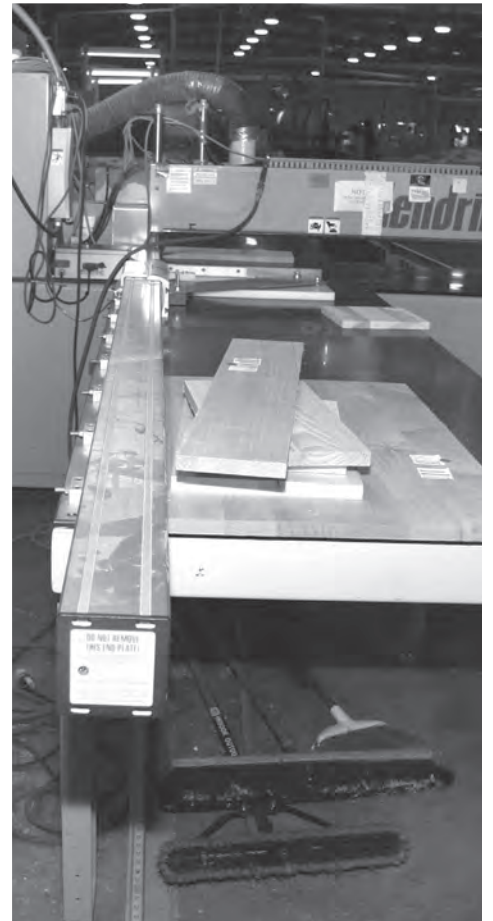
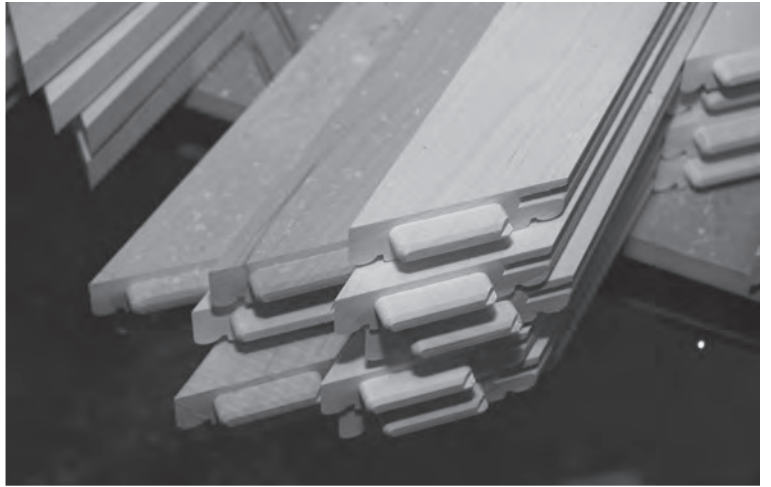
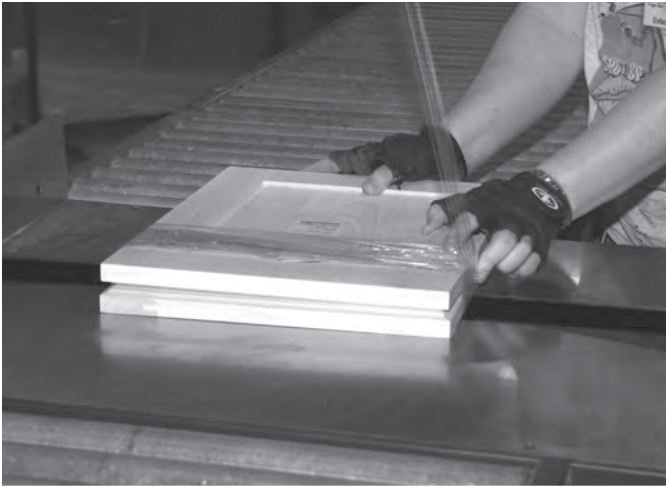

DRAWER FRONT STYLES • Solid Wood Slabs



DF
Slab with edge profile only
(Profiles on page 11)

Minimum Width: 4"
Minimum Height: 2"

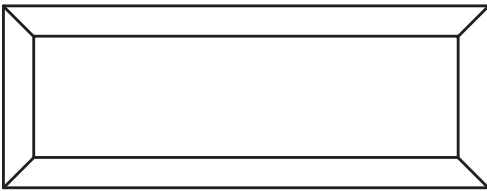

DF RPC P-1
Raised Panel Cut

Minimum Width: 6"
Minimum Height: 4-1/4"

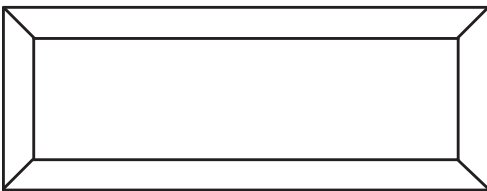
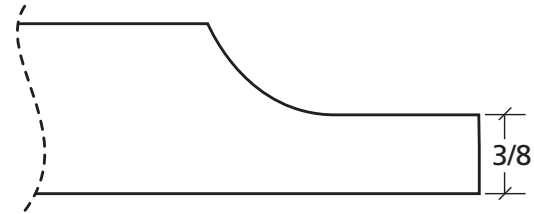

DF RPC-R P-1
Raised Panel Cut with Roundover

Minimum Width: 6"
Minimum Height: 4-1/4"

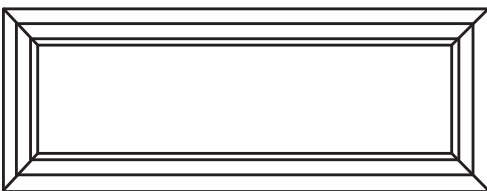
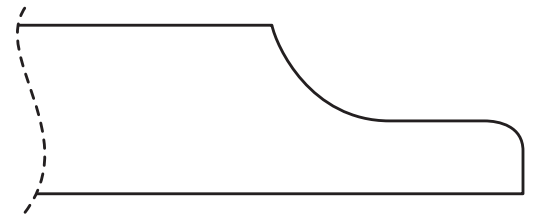

DF RPC P-2

Minimum Width: 6"
Minimum Height: 4-1/4"

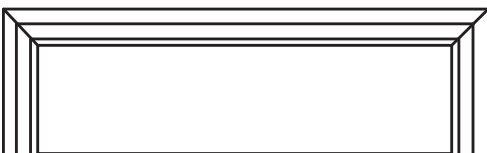
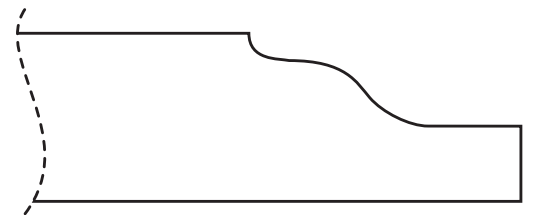

DF RPC-R P-2

Minimum Width: 6"
Minimum Height: 4-1/4"

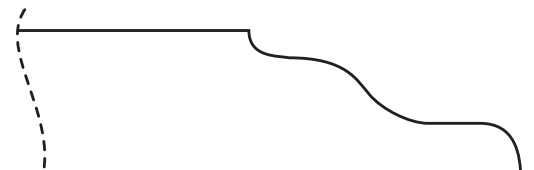

DRAWER FRONT STYLES • Solid Wood Slabs

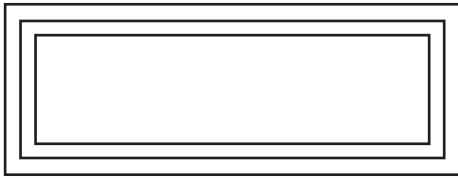

DF RPC P-3

Minimum Width: 6"
Minimum Height: 4-1/4"

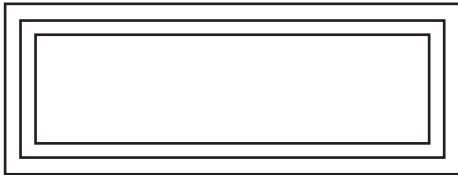
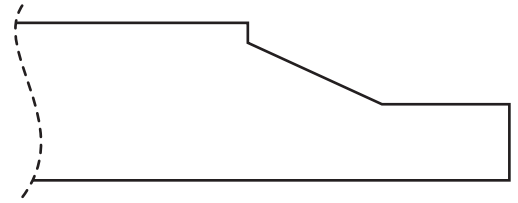

DF RPC-R P-3

Minimum Width: 6"
Minimum Height: 4-1/4"

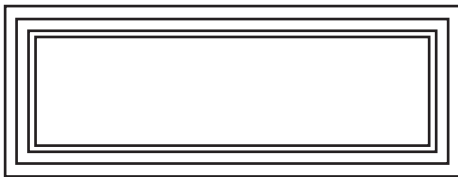
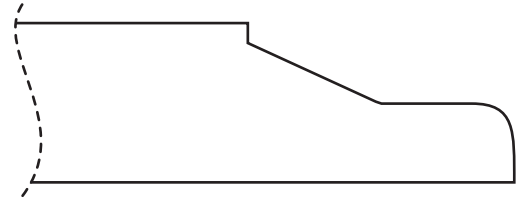

DF RPC P-4

Minimum Width: 6"
Minimum Height: 4-1/4"

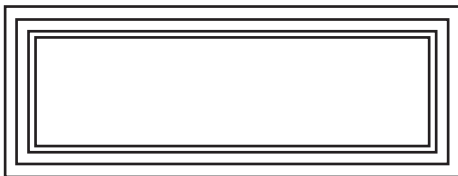
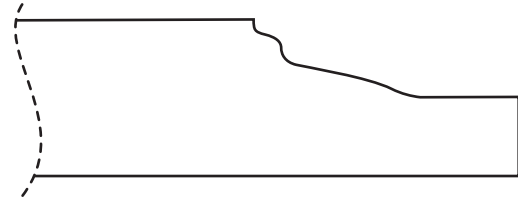

DF RPC-R P-4

Minimum Width: 6"
Minimum Height: 4-1/4"

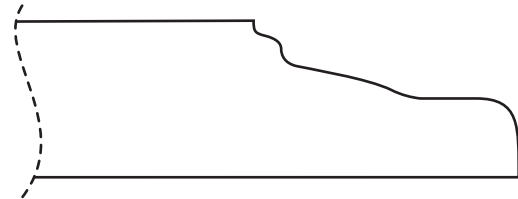

DF RPC P-5

Minimum Width: 6"
Minimum Height: 4-1/4"

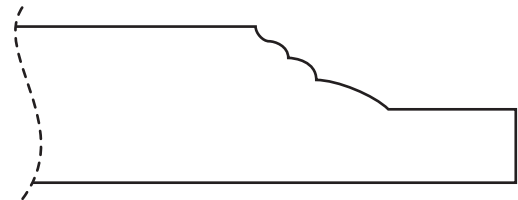

DF RPC-R P-5

Minimum Width: 6"
Minimum Height: 4-1/4"

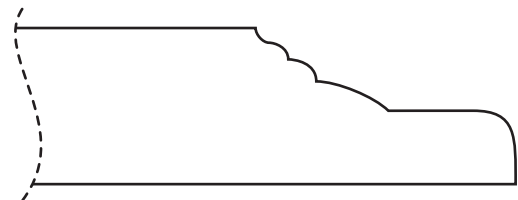

DRAWER FRONT STYLES • Cope & Stick



100 Series

Available with all Panel Profiles, Raised or Reversed, and in both R-1 and R-2 Rail Profiles

Available with Classic Bold Stiles.

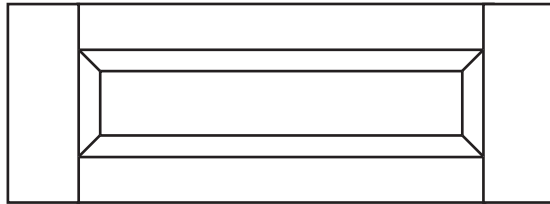

DF RP 1

Minimum Width: 9-3/4"
 Minimum Height: 6"
 1-3/8" Top & Bottom Rails
 2-1/4" Vertical Stiles

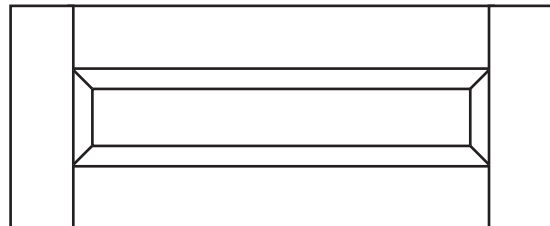

DF RP 2

Minimum Width: 9-3/4"
 Minimum Height: 8"
 2-1/4" Rails & Stiles

Solid Wood Rails • 1/4" Plywood Panels

200 Series

Available with R-1 or R-2 Rail & Stile Profile

Available with Classic Bold Stiles.

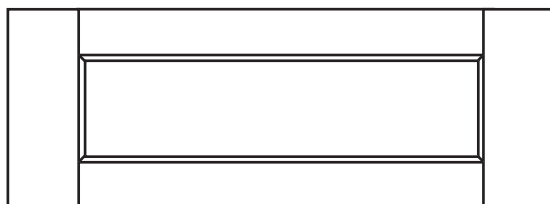

DF FP 1

Minimum Width: 7-1/2"
 Minimum Height: 5"
 1-3/8" Top & Bottom Rails
 2-1/4" Vertical Stiles

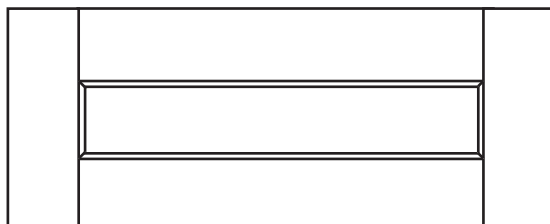

DF FP 2

Minimum Width: 7-1/2"
 Minimum Height: 6"
 2-1/4" Top & Bottom Rails
 2-1/4" Vertical Stiles

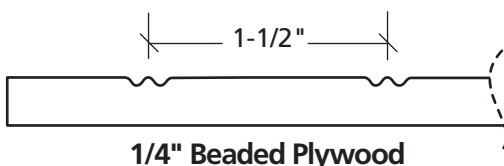

1/4" Beaded plywood is available in Red Oak and Maple only, on all 1/4" plywood panel drawer fronts. When ordering place a (B) at the end of drawer front letters (example DFFP1B).

DRAWER FRONT STYLES • Shaker Series Solid Wood Raised Panel

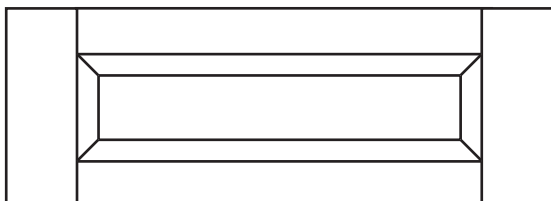
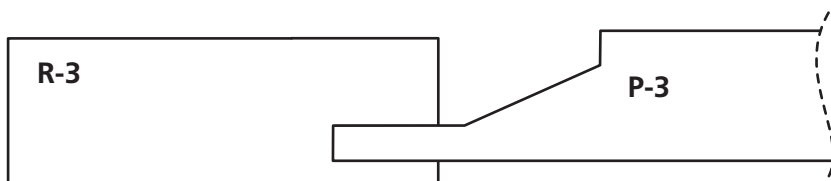

DF RP 701-1
 Minimum Width: 9-3/4"
 Minimum Height: 6"
 1-3/8" Top & Bottom Rails
 2-1/4" Vertical Stiles

700 Series

Available with all Raised Panel Profiles, with R-3 Rail Profile.

Available with Classic Bold Stiles.

P-3 Panel Profile recommended on all shaker and mission style.

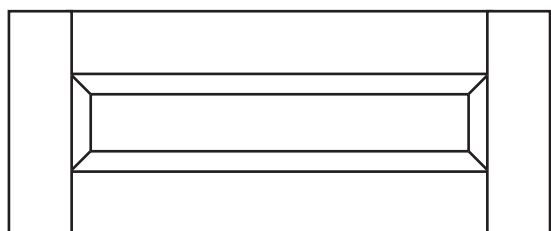

DF RP 701-2
 Minimum Width: 9-3/4"
 Minimum Height: 8"
 2-1/4" Rails & Stiles

700 Series • Applied Moulding Raised Panel

Available with Classic Bold Stiles.

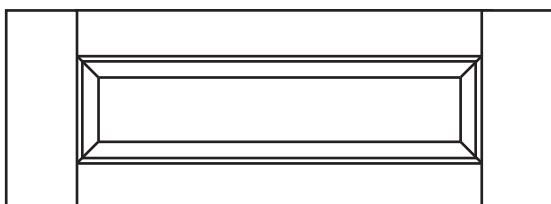

DF RP 701-1
 Minimum Width: 9-3/4"
 Minimum Height: 7"
 1-3/8" Top & Bottom Rails
 2-1/4" Vertical Stiles

MB10
MB11
MB12

Panel Profile P-1E available for the applied mouldings only.

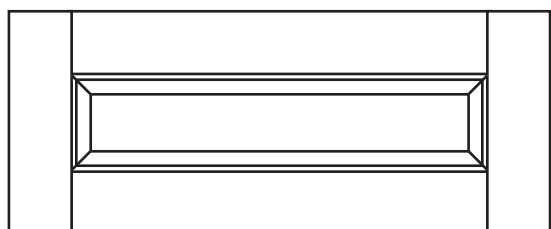

DF RP 701-2
 Minimum Width: 9-3/4"
 Minimum Height: 8"
 2-1/4" Rails & Stiles

MB10
MB11
MB12

See door cross sections on page 16.

NOTE: For door style 715CB-MB02 (see page 16 for door cross section) we recommend using solid drawer fronts with a 51 or 53 edge profile (see page 11 for edge profiles).

DRAWER FRONT STYLES • Shaker Series Reversed Solid Panel

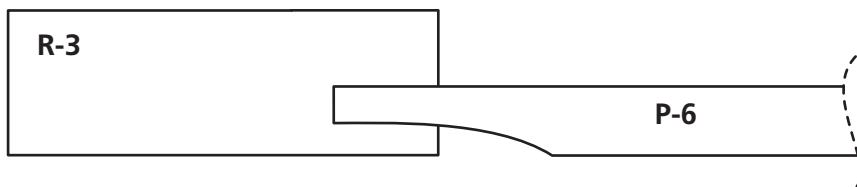

700 Series

Available with R-3 Rail & Stile Profile, P-6 or P-6B Panel Profile and Classic Bold Stiles only.

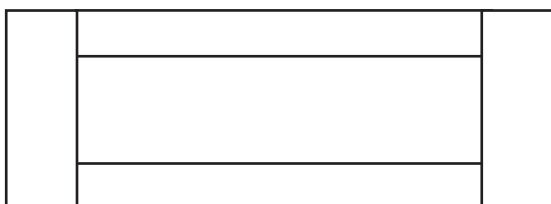

DF FP 701-1

Minimum Width: 9-3/4"
 Minimum Height: 6"
 1-3/8" Top & Bottom Rails
 2-1/4" Vertical Stiles

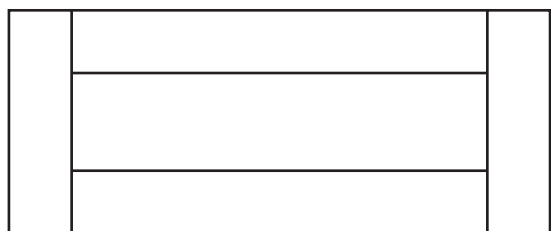

DF FP 701-2

Minimum Width: 9-3/4"
 Minimum Height: 8"
 2-1/4" Rails & Stiles

700 Series • Applied Moulding Reversed Solid Panel

Available with Classic Bold Stiles.

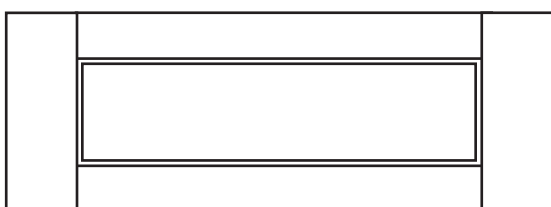

DF FP 701-1

Minimum Width: 9-3/4"
 Minimum Height: 7"
 1-3/8" Top & Bottom Rails
 2-1/4" Vertical Stiles

- MB10
- MB11
- MB12
- MB48
- MB244

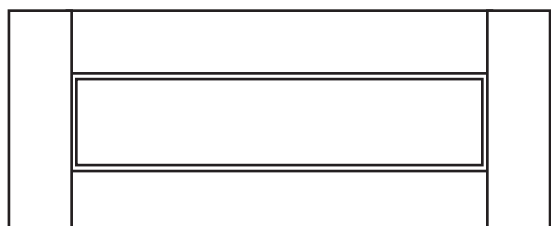

DF FP 701-2

Minimum Width: 9-3/4"
 Minimum Height: 8"
 2-1/4" Rails & Stiles

- MB10
- MB11
- MB12
- MB48
- MB244

DRAWER FRONT STYLES • Shaker Series 1/4" Plywood Panels

500 Series

Available with R-3 Rail & Stile Profile only. See Beaded Plywood Panel note on page 14.

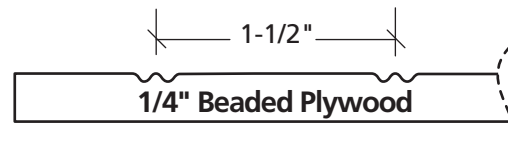
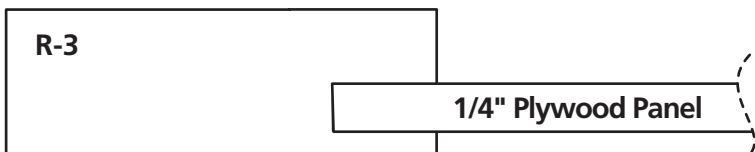

NOTE: See page 14 NOTE on 1/4" Plywood

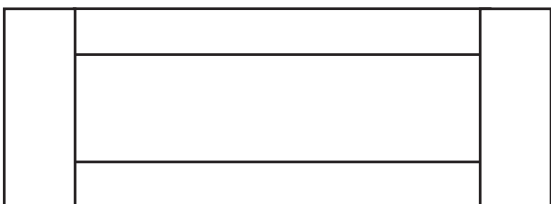

DF FP 501-1

Minimum Width: 7-1/2"
Minimum Height: 5"
1-3/8" Top & Bottom Rails
2-1/4" Vertical Stiles

Available with Classic Bold Stiles.

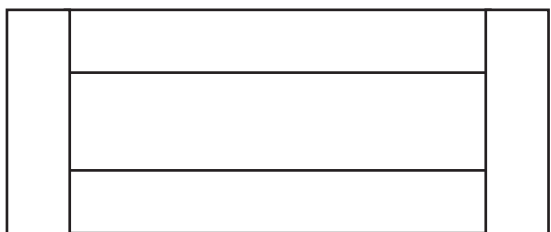

DF FP 501-2

Minimum Width: 7-1/2"
Minimum Height: 6"
2-1/4" Rails & Stiles

500 Series • Applied Moulding 1/4" Plywood

Available with Classic Bold Stiles.

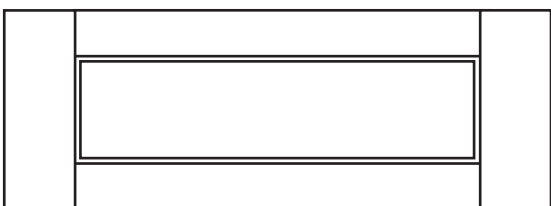

DF FP 501-1

Minimum Width: 7-1/2"
Minimum Height: 6"
1-3/8" Top & Bottom Rails
2-1/4" Vertical Stiles

- MB10
- MB11
- MB12
- MB48
- MB244

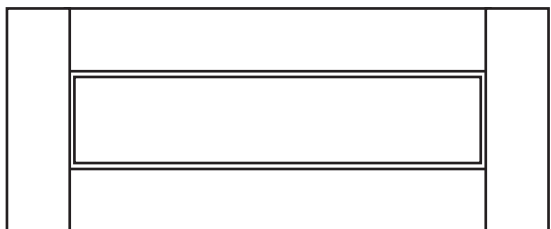

DF FP 501-2

Minimum Width: 7-1/2"
Minimum Height: 7-1/2"
2-1/4" Rails & Stiles

- MB10
- MB11
- MB12
- MB48
- MB244

DRAWER FRONT STYLES • Mitered Raised Panels & Reversed Solid Panel

See page 10 for Panel Profiles.

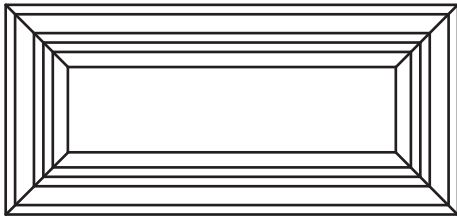

DF RP 145

Minimum Width: 8-3/4"
Minimum Height: 6"

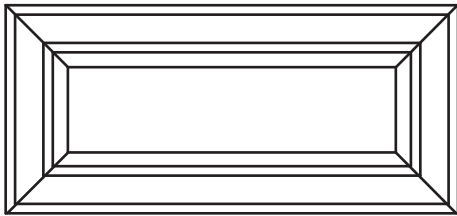
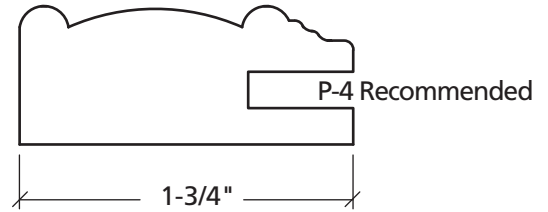

DF RP 146

Minimum Width: 8-3/4"
Minimum Height: 6"

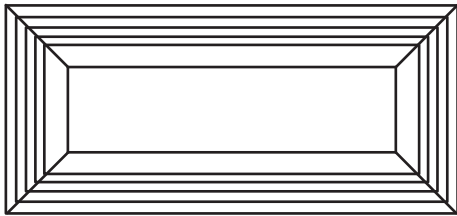
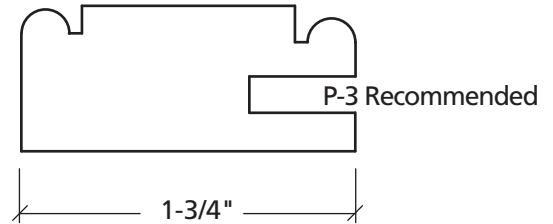

DF RP 147

Minimum Width: 8-3/4"
Minimum Height: 6"

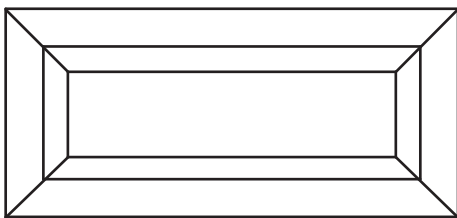
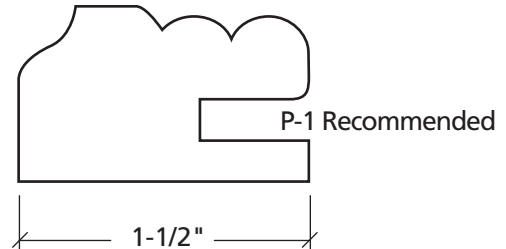

DF RP 149

Minimum Width: 8-3/4"
Minimum Height: 6"

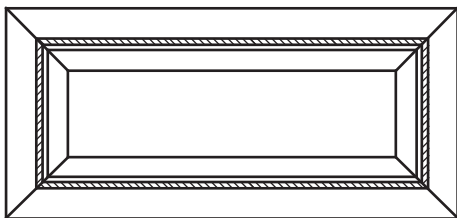
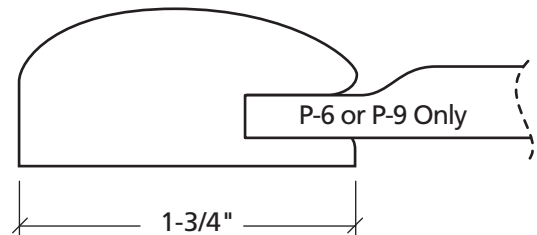

DF RP 150

Minimum Width: 8-3/4"
Minimum Height: 6"

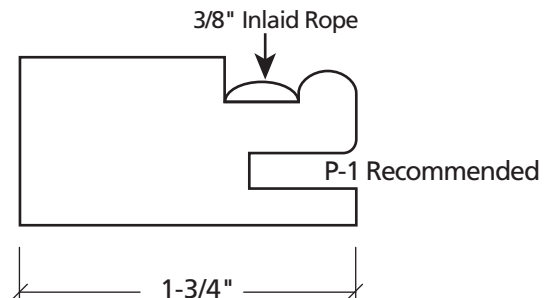

DRAWER FRONT STYLES • Mitered 1/4" Plywood Panels

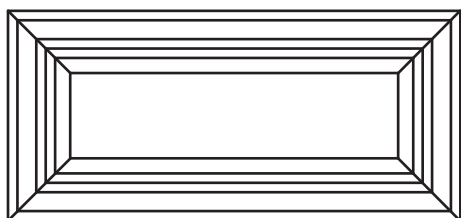

DF FP 245

Minimum Width: 8-3/4"
Minimum Height: 6"

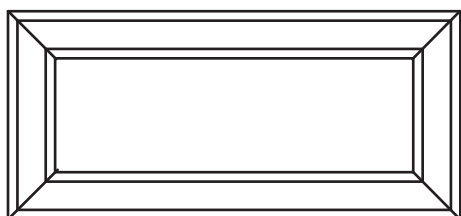
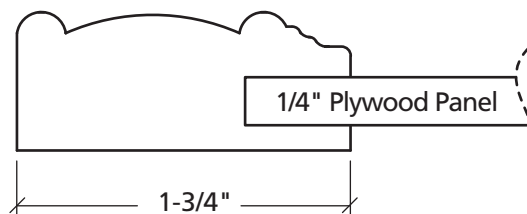

DF FP 246

Minimum Width: 8-3/4"
Minimum Height: 6"

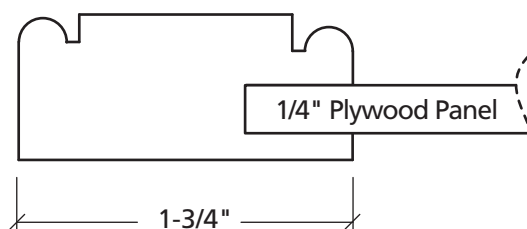

DF FP 247

Minimum Width: 8-3/4"
Minimum Height: 6"

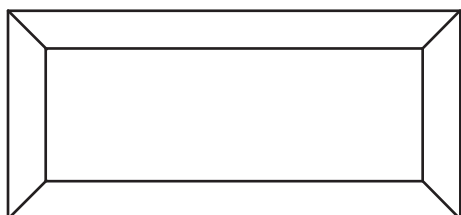
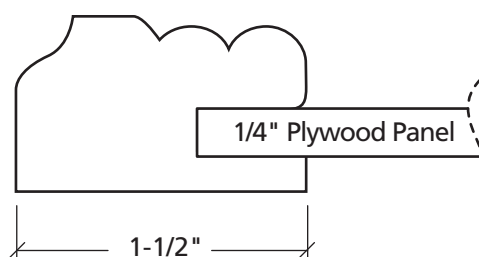

DF FP 249

Minimum Width: 8-3/4"
Minimum Height: 6"

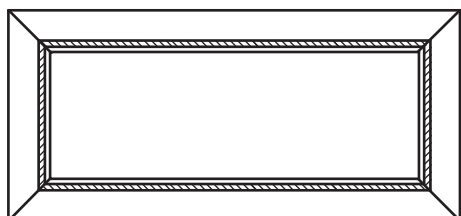
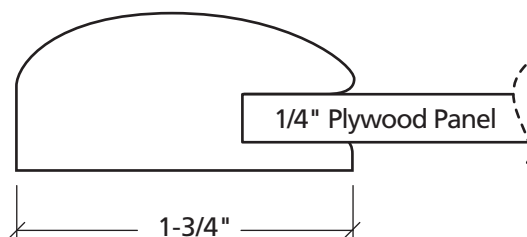

DF FP 250

Minimum Width: 8-3/4"
Minimum Height: 6"

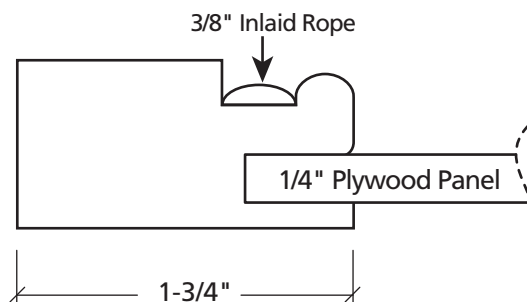

DRAWER FRONT STYLES • MDF

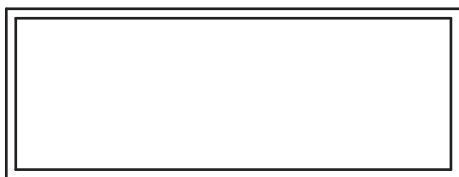

DF MDF
Slab with 52 edge profile only

Minimum Width: 4"
Minimum Height: 2"

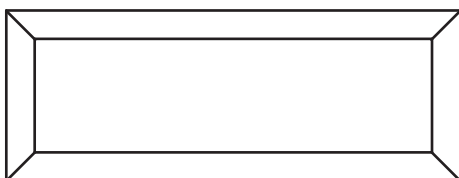

DF RPC MDF
Raised Panel Cut

Minimum Width: 6"
Minimum Height: 4-1/4"

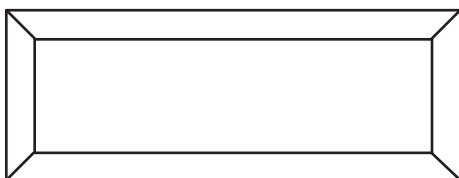
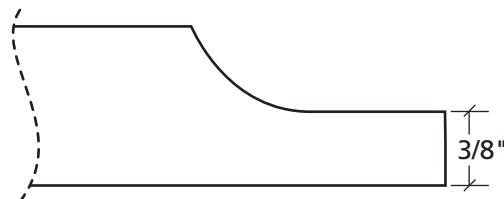

DF RPC-R MDF
Raised Panel Cut
with Roundover

Minimum Width: 6"
Minimum Height: 4-1/4"

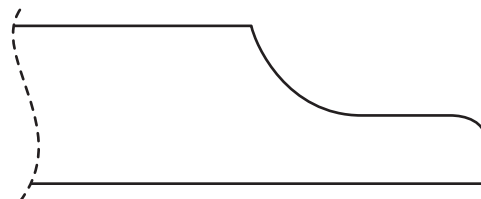

NOTE: DF RPC P-2, P-3, P-4, P-5 are available in wood only

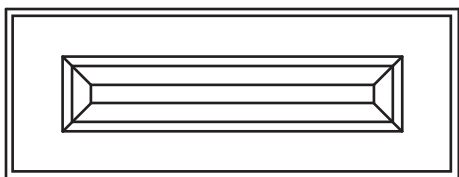

DF RP 401 Raised Panel
with 52 edge profile only

Minimum Width: 7-1/2"
Minimum Height: 6"
1-1/2" Top & Bottom Rails

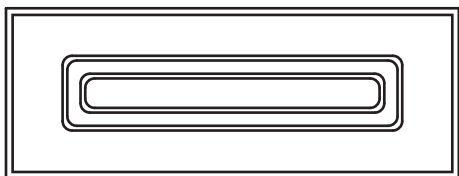

DF RP 301 Raised Panel
with 52 edge profile only

Minimum Width: 7-1/2"
Minimum Height: 6"
1-1/2" Top & Bottom Rails

WAINSCOT - END PANELS - BAR BACKS

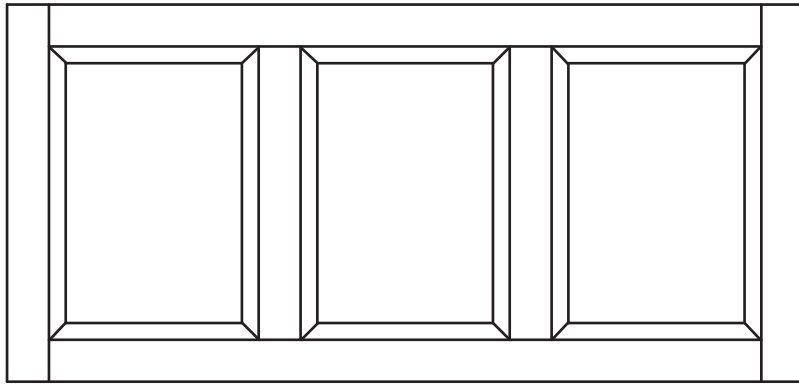

WAINSCOT / BARBACK

Solid Wood, 1/4" Plywood or MDF

Available with customized Stile & Rail sizes.

When ordering specify:

- Door Style
- Panel Style
- Stile & Rail sizes
- Number of Raised Panels
- Available in R1, R2, R3 Rail & Stile Profiles. (Profiles on Page 9)

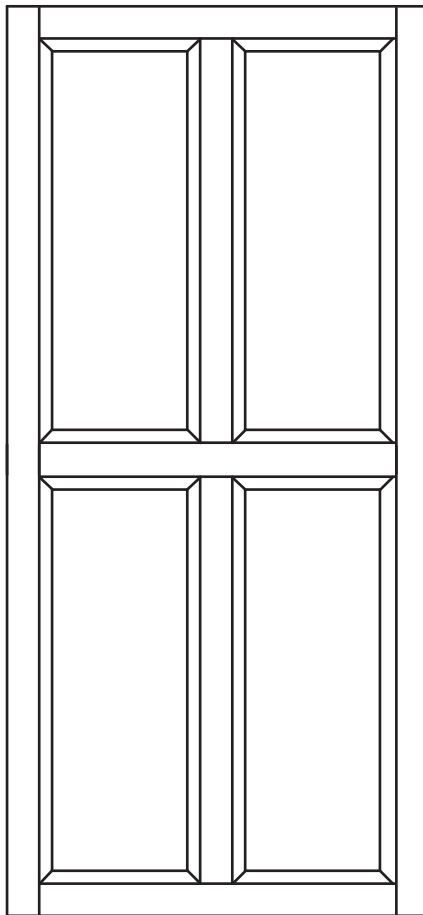

END PANEL

A DRAWING OR TEMPLATE MUST BE SUPPLIED FOR ALL END PANELS, ARCH PANELS AND RANGE HOOD PANELS

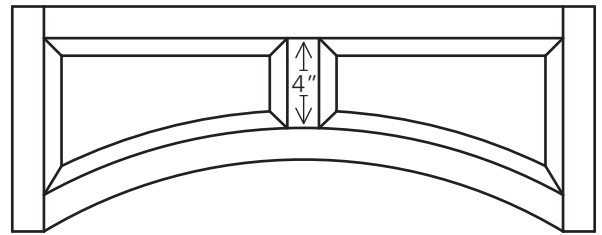

CUSTOM ARCH PANEL

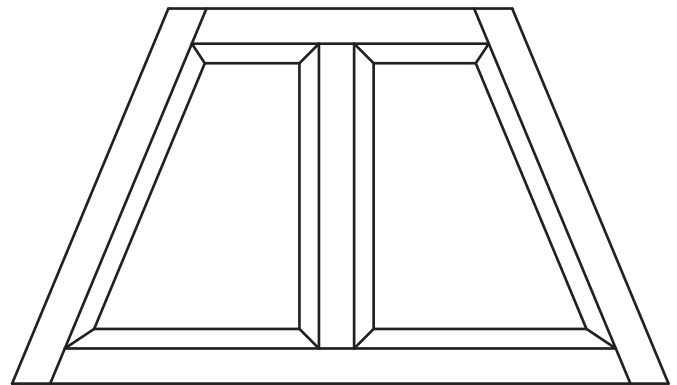

RANGE HOOD PANEL



CUSTOM VALANCE (Solid Wood / MDF)

HINGE PREP • European Bore / Knife

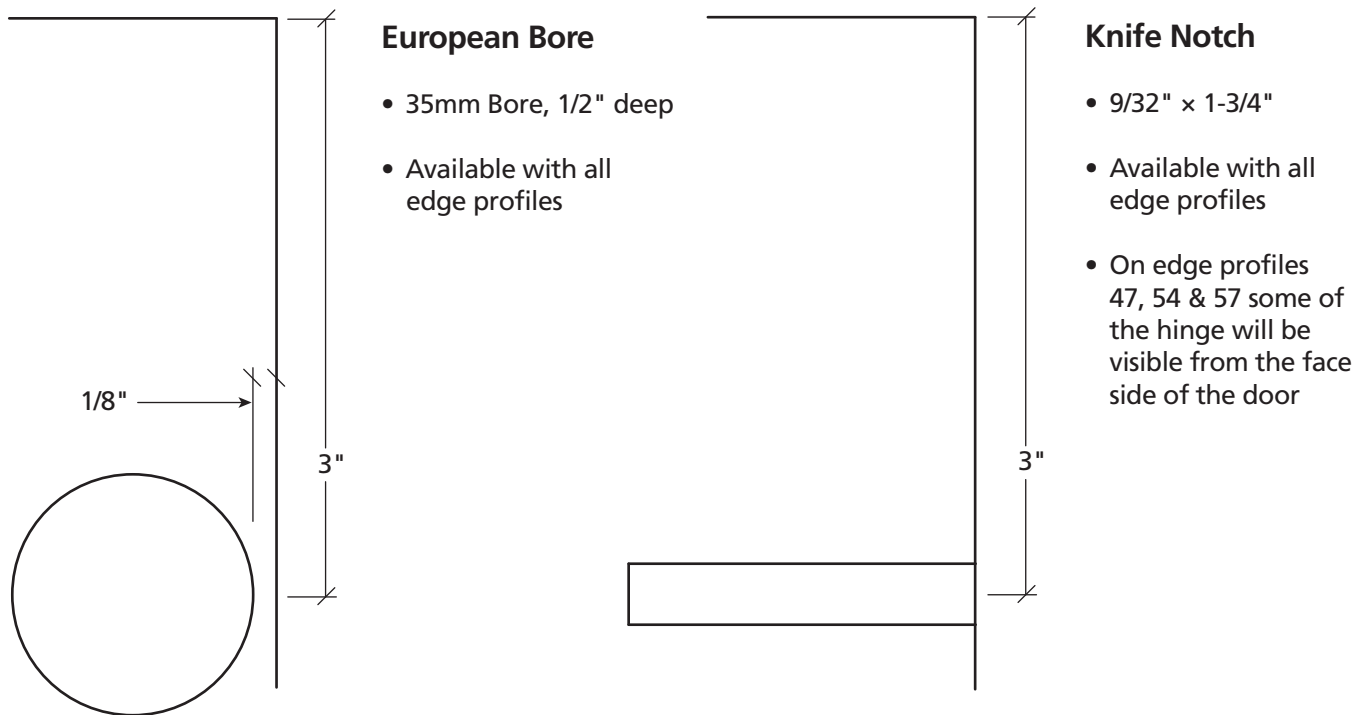

- Doors up to 41-15/16" high = 2 hinges
- Doors 42" high and above = 3 hinges

- When ordering arched doors, specify side to be bored or notched.

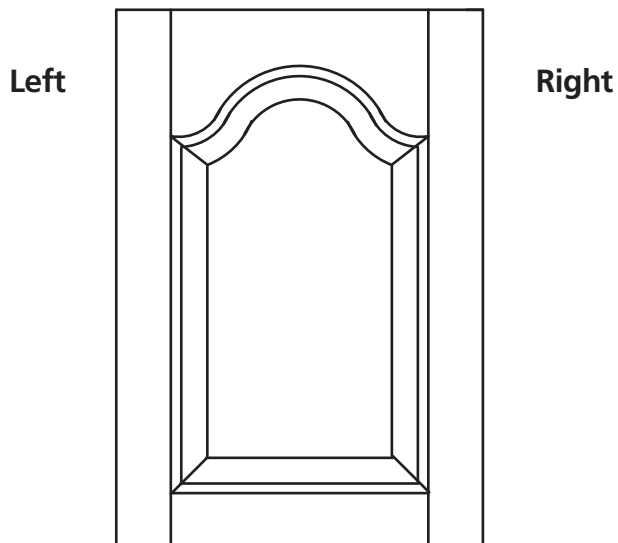

APPLIANCE PANELS

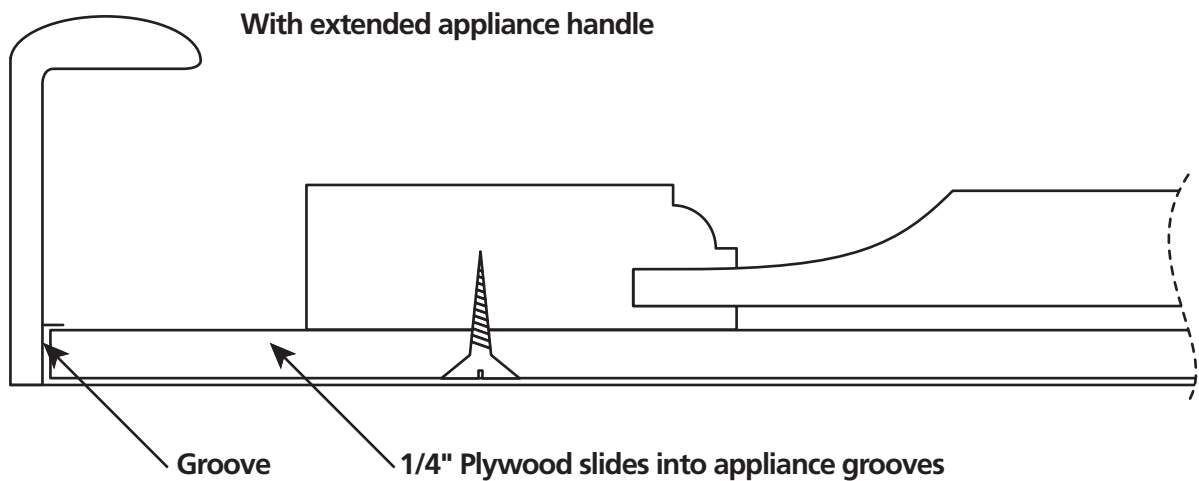
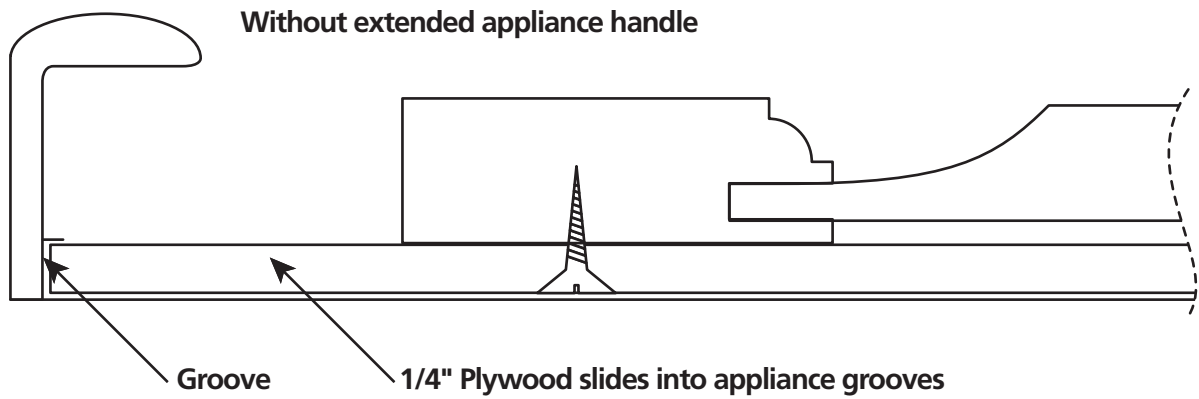

- Appliance Panels are offered in any door style.
- 1/4" Plywood supplied by customer.

DRAWER BOXES

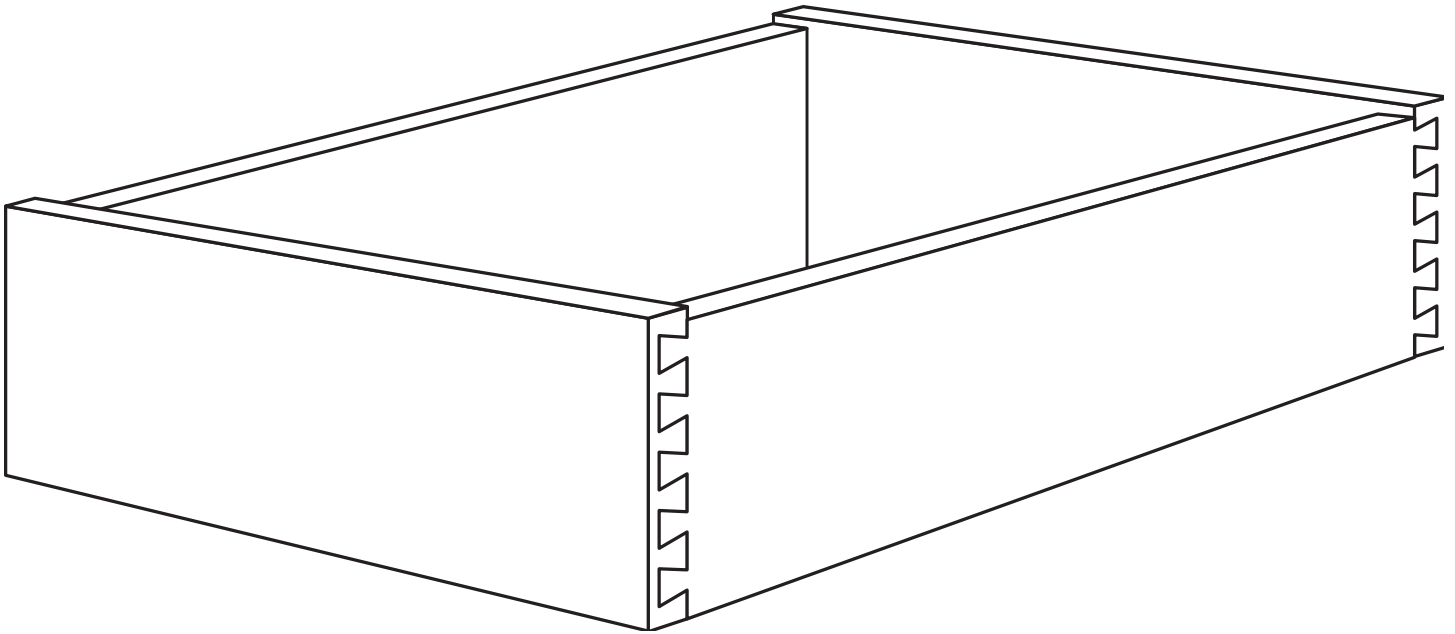

- Half-inch, 9-ply Birch Plywood or Solid Maple sides
- Custom Order Width & Depth
- Heights 2-1/8" Minimum to 22-1/8" Maximum in 1" increments
(Example: 2-1/8", 3-1/8", 4-1/8", 5-1/8", etc)

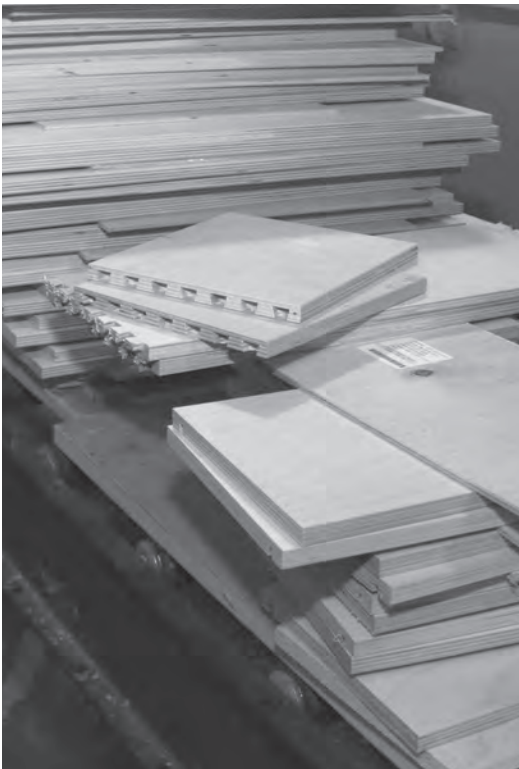

MOULDING

The profiles on pages 48 through 54 represent mouldings that we stock in four wood specie: poplar, northern soft maple, alder, and red oak. All other wood species are custom run by order. Please note on page 54 our S4S face frame stock; this can also be custom run in special widths in any wood specie. Please allow 10 working days for custom moulding orders.



MOULDING

MB121 • 5-1/4" Dentil Crown

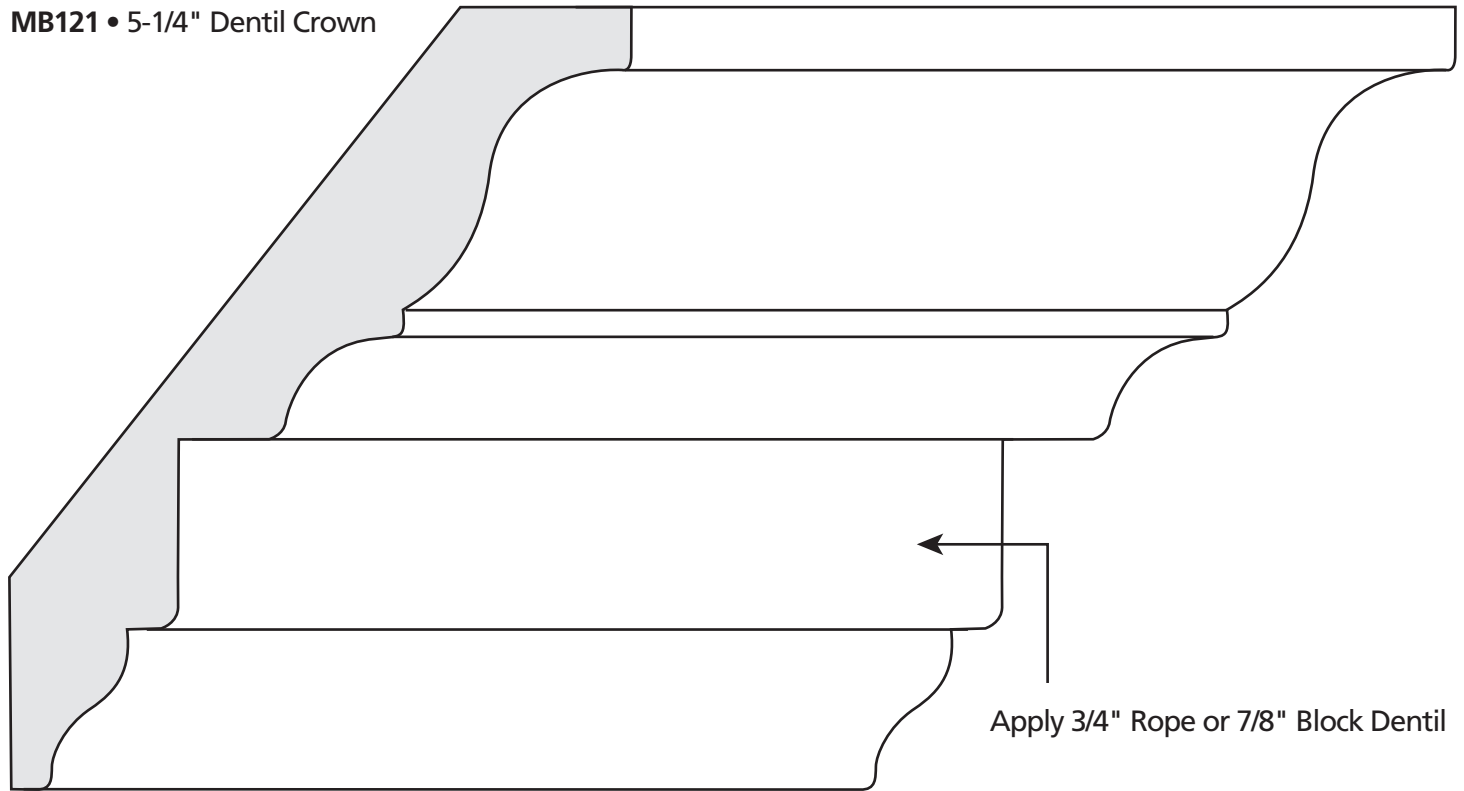

MB92 • 4-1/4" Dentil Crown

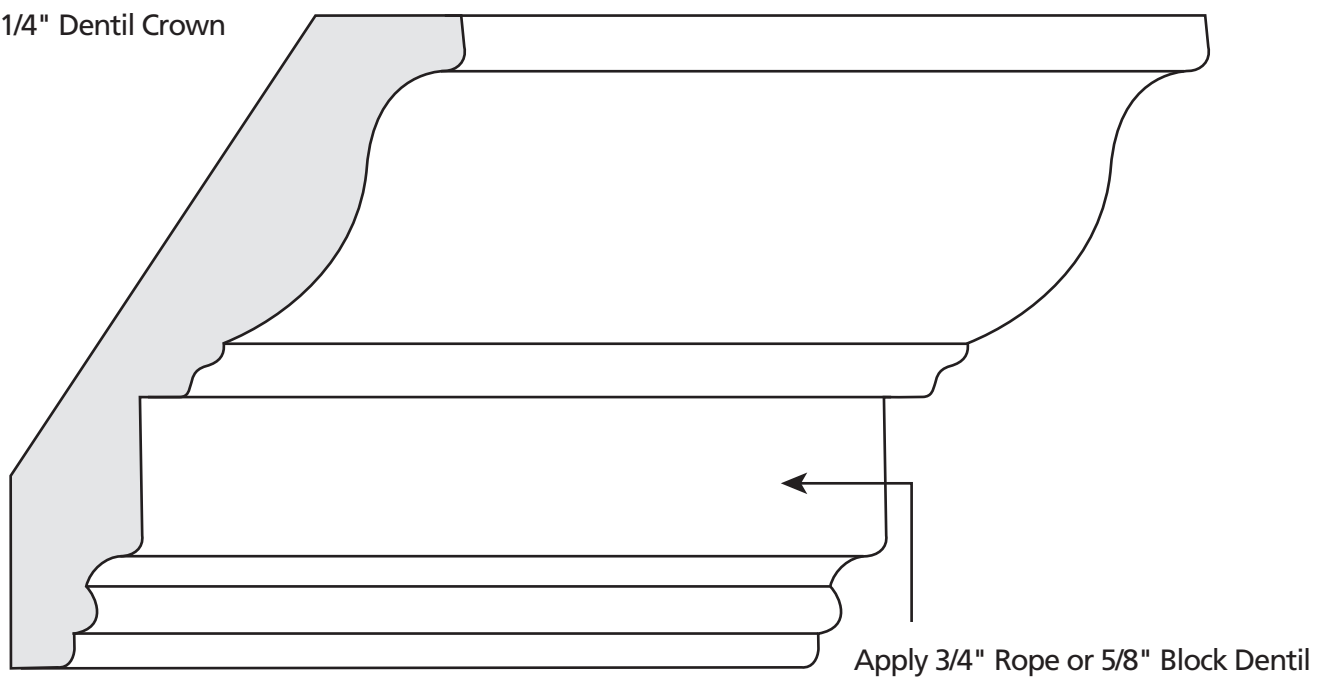

MOULDING

MB • 3/4" Rope

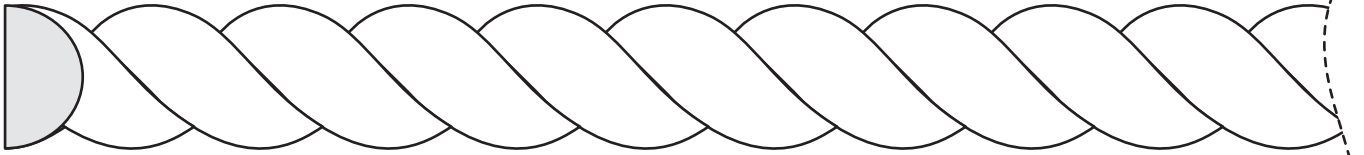

MB • 3/8" Rope



MB26 • 1-1/8" Raised Panel Dentil

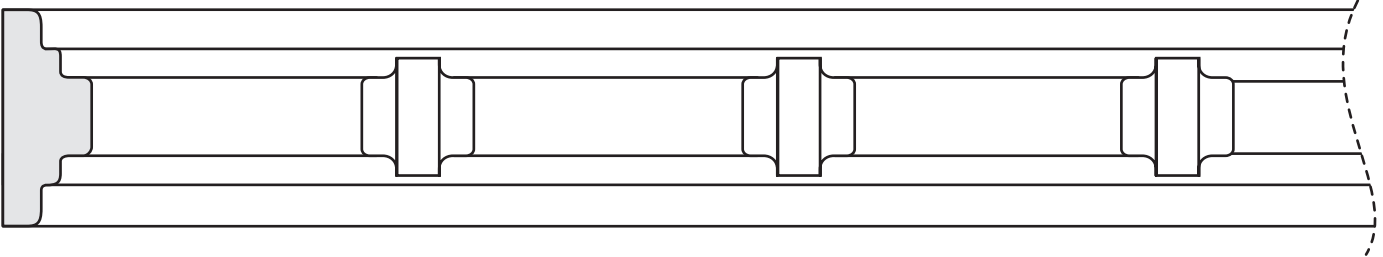

MB27 • 7/8" Block Dentil

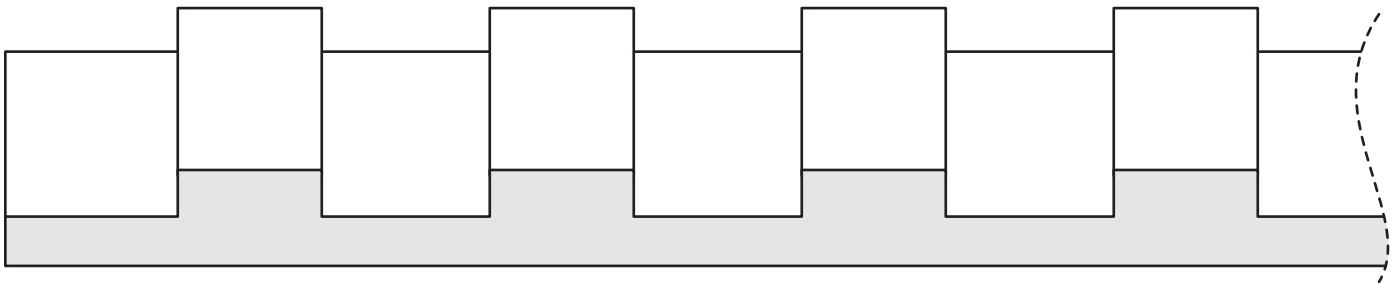

MB47 • 5/8" Block Dentil

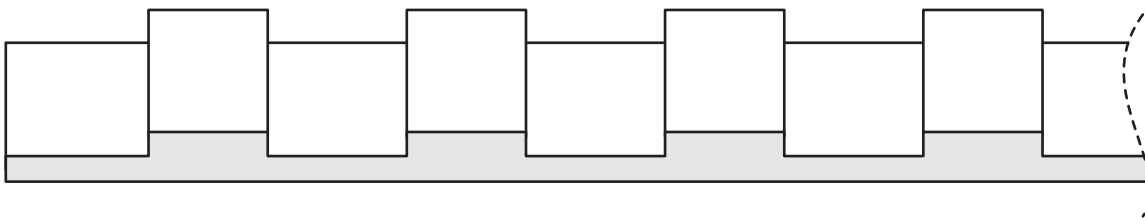

MB17 • 1/2" x 1-1/2" Half Round

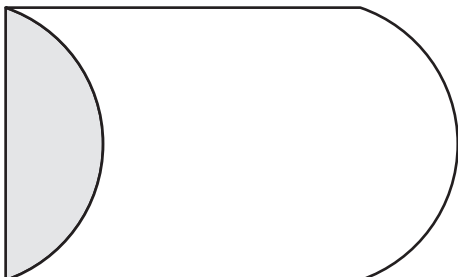

MB16 • 1/2" x 1" Half Round



MB15 • 1/2" x 3/4" Half Round

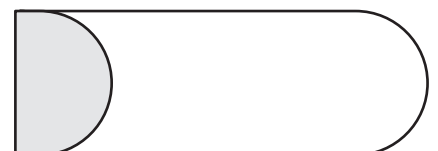

MOULDING

MB100 • 2-1/4" Colonial Crown

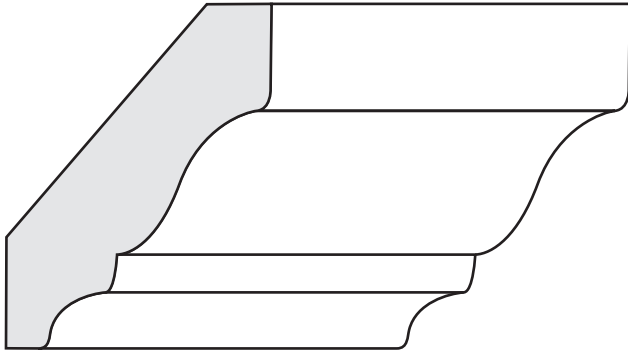

MB101 • 3-1/4" Colonial Crown

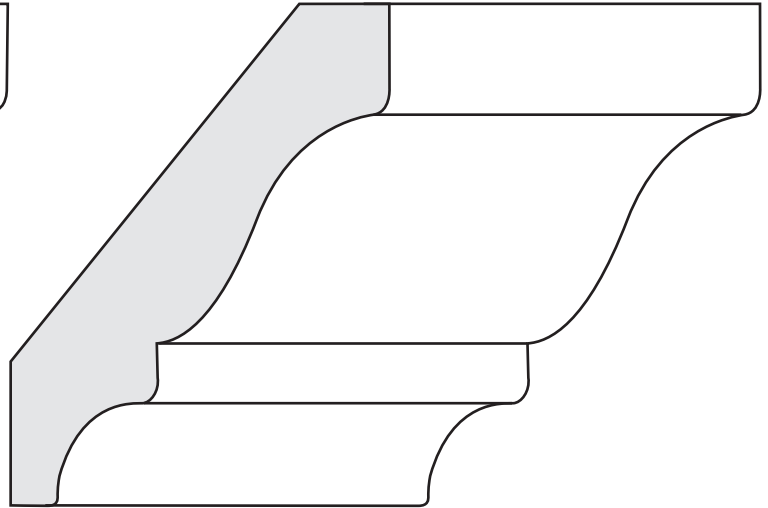

MB102 • 4-1/4" Colonial Crown

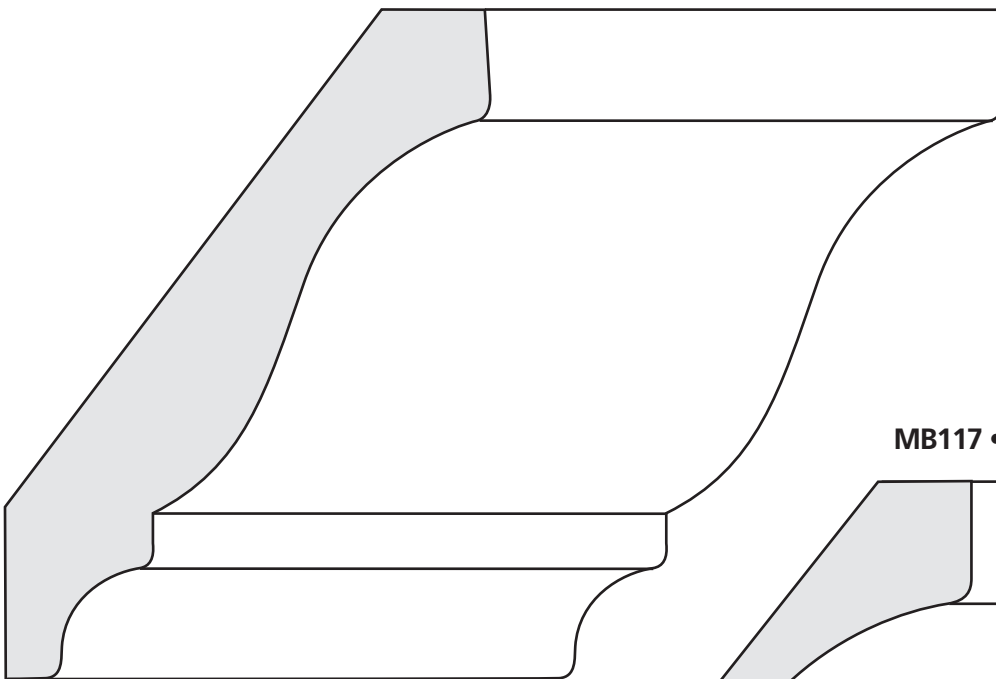

MB117 • 3-3/4" Custom Cove

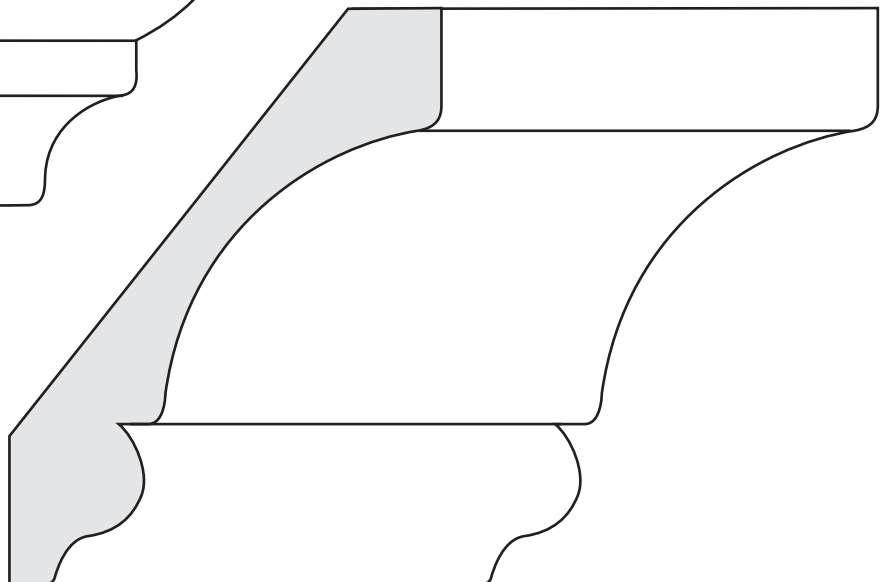

MB90 • 1-3/4" Bed Mould

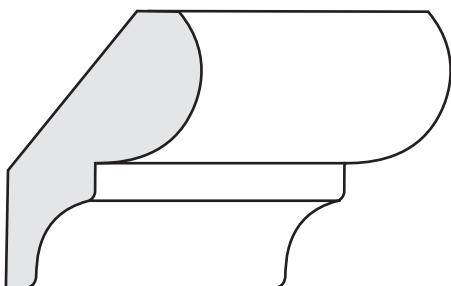

MOULDING

MB175 • 2-1/4" Colonial Casing

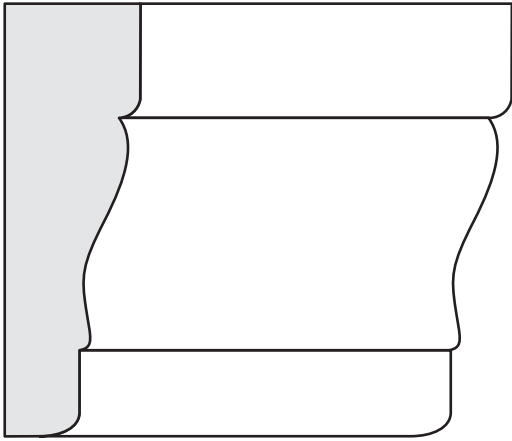

MB180 • 3-1/4" 399 Casing

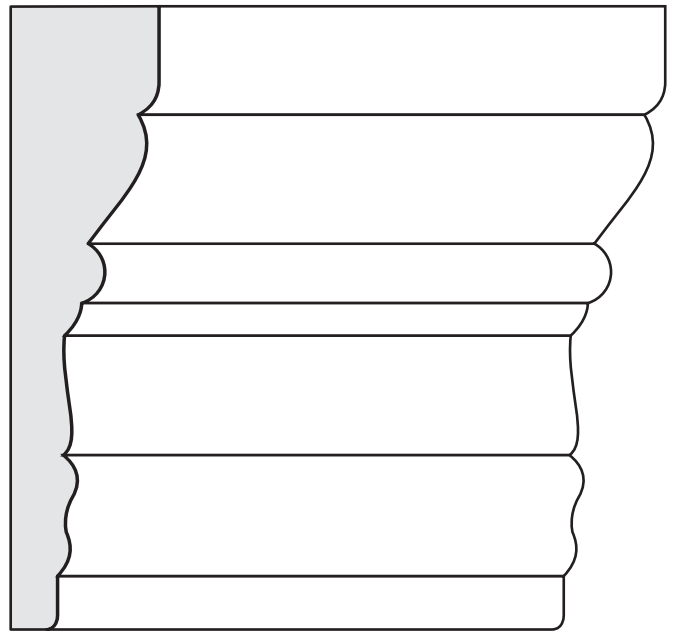

MB191 • 4-1/4" Fluted Casing

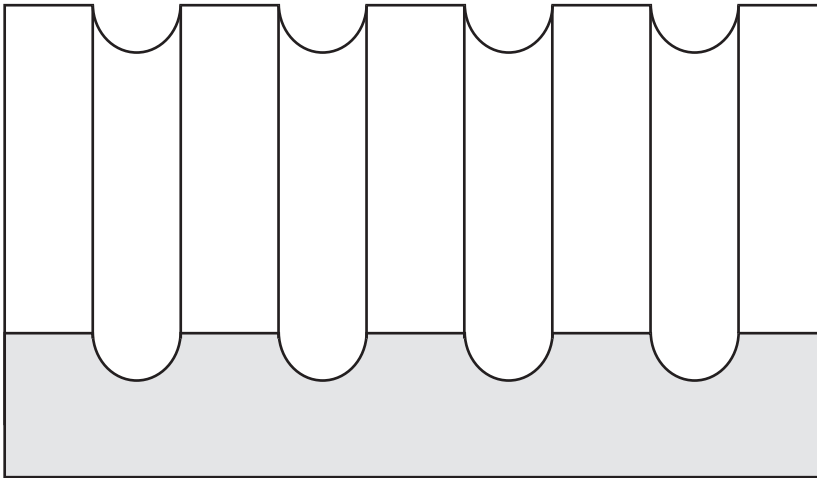

MB190 • 3-1/4" Fluted Casing

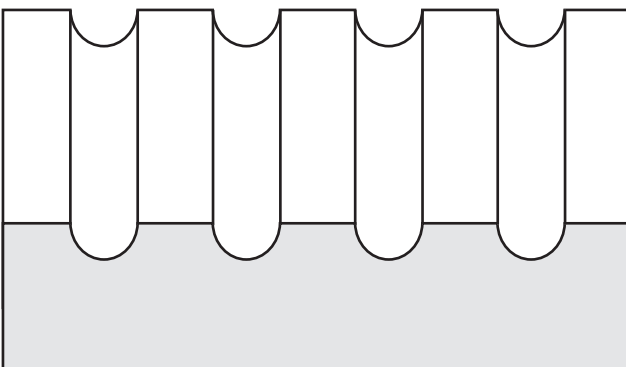

MB129 • 3-1/4" Crown Apron or Baseboard

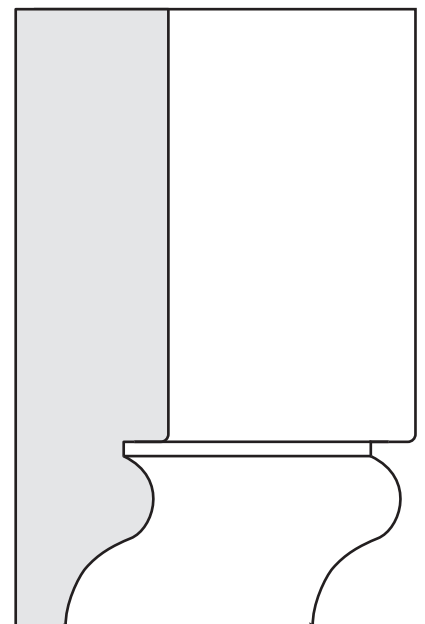

MOULDING

MB31 • 1-1/2" St. Ann's

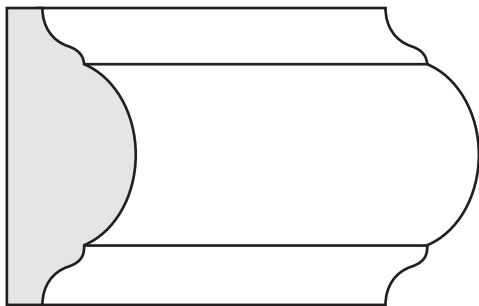

MB32 • 1-7/8" Formica Band

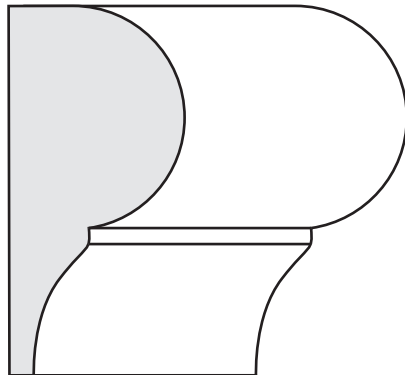

MB91 • 2" Bed Trim

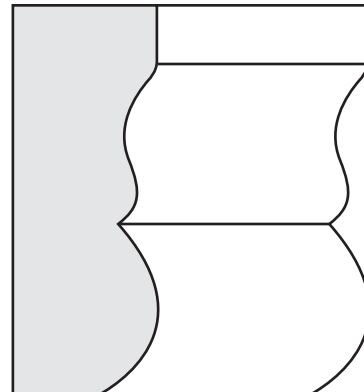

MB39 • 1-3/4" Decorative

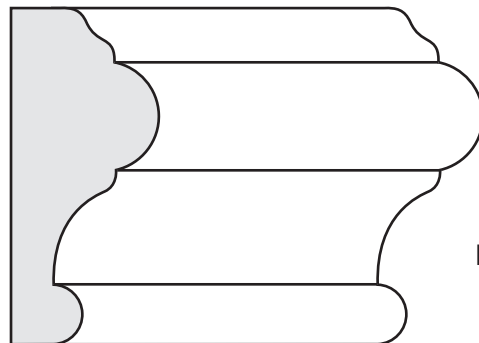

MB34 • 1-3/4" Formica Band



MB241 • Inside Panel

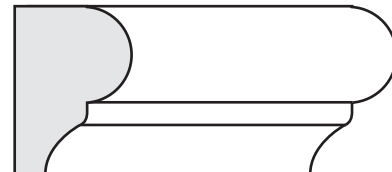

MB150 • 1-1/2" Base Cap

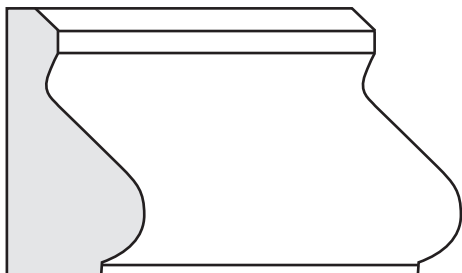

MB36 • 2-1/4" Decorative Formica Band

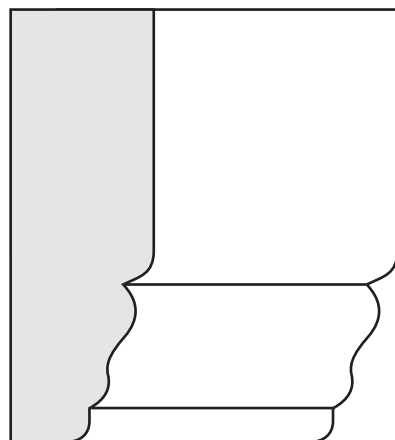

MB240 • 1" Inside Panel

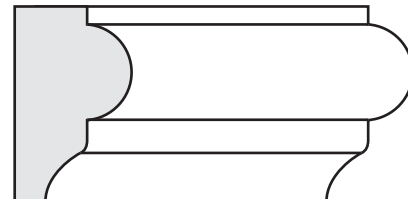

MB40 • 1-1/4" Decorative



MB35 • 1-5/8" Decorative Formica Band

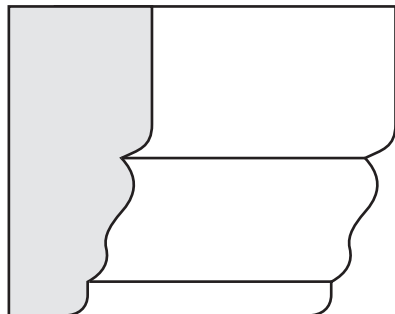

MB11 • 1/4" x 3/4" Shadow



MB225 • 1-5/8" Undercabinet or Cap Rail

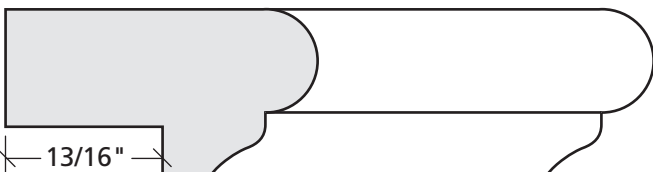

MB30 • 3/4" x 2" Offset Cabinet

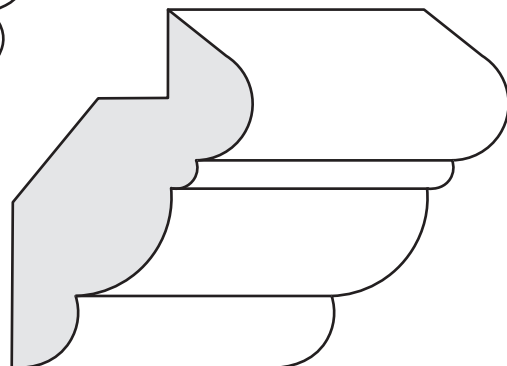

MOULDING

MB10 • 3/4" Inside Lip

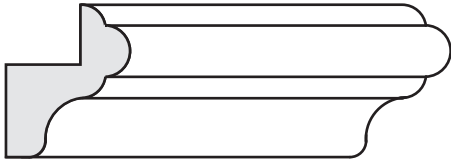

MB02 • 1-1/2" Inside Lip

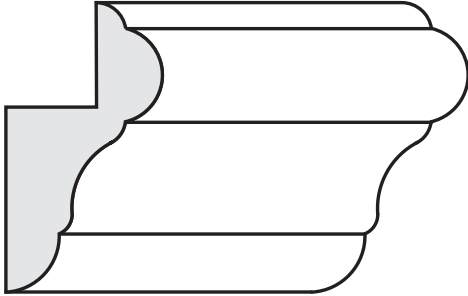

MB48 • 1-1/16" Inside Lip

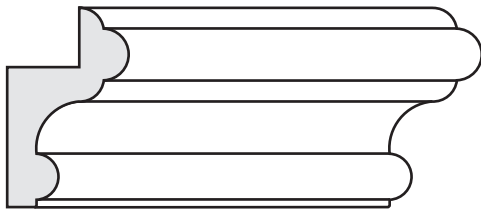

MB252 • 1-1/4" 45° Corner

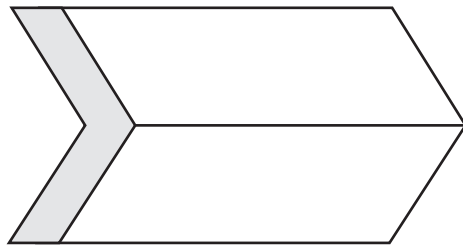

MB25 • 3/4" x 1" Furr Down



MB21 • 3/4" x 3/4" Fluted Chamfer

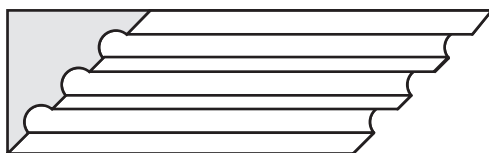

MB295 • 1 x 1-3/4" Window Stool

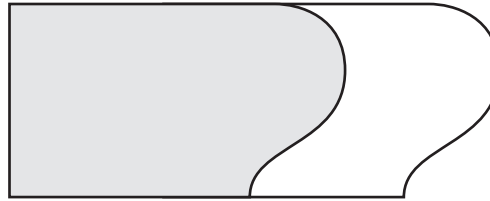

MB253 • 1-1/8" x 1-1/8" Outside Corner

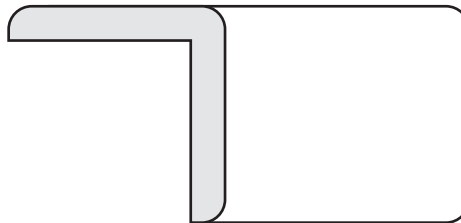

MB254 • 3/4" x 3/4" Outside Corner



MB23 • 1/4" x 3/4" 2 Bead Screen

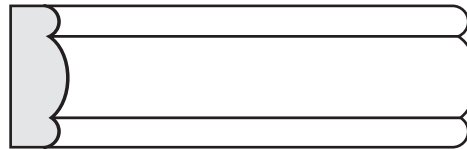

MB24 • 1/4" x 3/4" Plain Screen



MB22 • 3/4" x 3/4" Flat Chamfer



MB250 • 3/4" x 3/4" Scocia

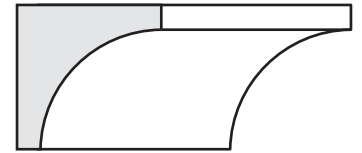

MB156 • 3/4" x 3/4" Quarter Round

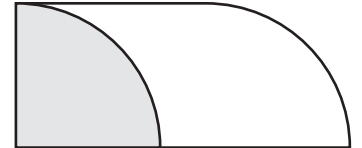

MB155 • 1/2" x 3/4" Shoe

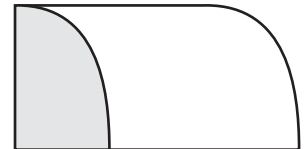

MB41 • 3/4" Beauty



MB42 • 5/8" Beauty

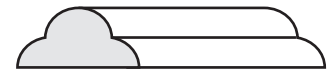

MB20 • 1-1/8" "J" Mould



MB244 • 1-1/8" Scribe

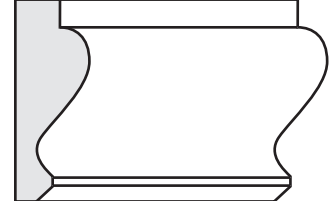

MB14 • 3/4" Scribe



MOULDING

S4S • 3/4" x 1-1/2"



S4S • 3/4" x 2-1/4"



S4S • 3/4" x 3"



S4S • 3/4" x 6"

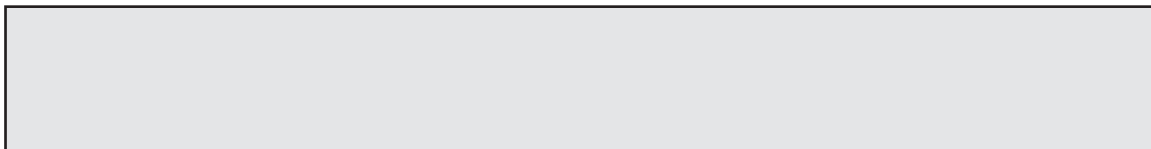

S4S • 3/4" x 8"



NOTE: We can custom run S4S widths in any wood specie. In some species, such as alder and northern soft maple, 6" and especially 8" widths are more difficult to obtain.

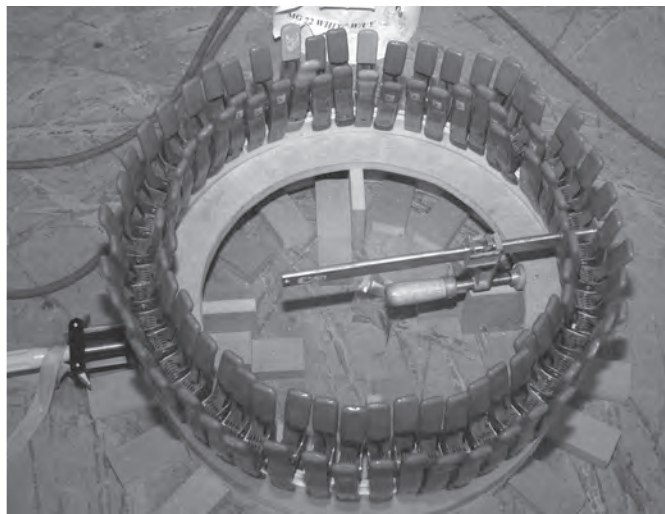



Morgan Bros.
Millwork, Inc.

PO Box 4343 • Laurel, MS 39441

For General Information

Local • 601-649-9188

Toll Free • 800-627-3667

Fax • 601-425-9732